

LENNTECH

info@lennotech.com Tel. +31-152-610-900

www.lennotech.com Fax. +31-152-616-289

High-pressure In-line Pump

Movitec

50 Hz

Type Series Booklet



Legal information/Copyright

Type Series Booklet Movitec

All rights reserved. The contents provided herein must neither be distributed, copied, reproduced, edited or processed for any other purpose, nor otherwise transmitted, published or made available to a third party without the manufacturer's express written consent.

Subject to technical modification without prior notice.

© KSB Aktiengesellschaft, Frankenthal 23.01.2015

Contents

High-pressure Pumps	5
High-pressure In-line Pumps	5
Movitec	5
Main applications	5
Fluids handled	5
Operating data	5
Designation	5
Further information on the designation	5
Design details	6
Materials	7
Coating and preservation	7
Product benefits	7
Product information as per Regulation No. 547/2012 (for water pumps with a maximum shaft power of 150 kW) implementing "Ecodesign" Directive 2009/125/EC	7
Acceptance tests / Warranties	7
Selection information	8
Information about the characteristic curve	8
Fluid handled	8
Minimum/maximum flow rate	8
Programme overview / selection tables	9
Table of fluids handled	9
Shaft seal	12
Pressure and temperature limits	13
Movitec A, B	13
Material variants	13
Technical data	14
Motors	14
Types of connection	15
Terminal box positions	15
Selection charts	16
Movitec; n = 2900 rpm	16
Movitec; n = 1450 rpm	17
Characteristic curves	17
n = 2900 rpm	18
Movitec; 2B; n = 2900 rpm	18
Movitec; 4B; n = 2900 rpm	19
Movitec; 6B; n = 2900 rpm	20
Movitec; 10B; n = 2900 rpm	21
Movitec; 15B; n = 2900 rpm	22
Movitec; 25B; n = 2900 rpm	23
Movitec; 40B; n = 2900 rpm	24
Movitec; 60B; n = 2900 rpm	25
Movitec; 90B; n = 2900 rpm	26
Movitec; LHS 6; n = 2900 rpm	27
n = 1450 rpm	28

Movitec; 10B; n = 1450 rpm	28
Movitec; 15B; n = 1450 rpm	29
Movitec; 25B; n = 1450 rpm	30
Movitec; 40B; n = 1450 rpm	31
Movitec; 60B; n = 1450 rpm	32
Movitec; 90B; n = 1450 rpm	33
Dimensions	34
Movitec, 2B, n = 2900 rpm	34
Movitec, 4B, n = 2900 rpm	35
Movitec, 6B, n = 2900 rpm	36
Movitec, 10B, n = 1450 rpm	37
Movitec, 10B, n = 2900 rpm	38
Movitec, 15B, n = 1450 rpm	39
Movitec, 15B, n = 2900 rpm	40
Movitec, 25B, n = 1450 rpm	41
Movitec, 25B, n = 2900 rpm	42
Movitec, 40B, n = 1450 rpm	43
Movitec, 40B, n = 2900 rpm	44
Movitec, 60B, n = 1450 rpm	45
Movitec, 60B, n = 2900 rpm	46
Movitec, 90B, n = 1450, 2900 rpm	47
Movitec, LHS 6, n = 2900 rpm	48
Installation information	49
Scope of supply	51
Accessories	51
General assembly drawing with list of components	52
Movitec 2B, 4B, 6B	52
Movitec 10B, 15B	53
Movitec 25B, 40B, 60B	54
Movitec 90B	55
Movitec LHS 6	56
Detailed designation	57

High-pressure Pumps

High-pressure In-line Pumps

Movitec



Main applications

- Spray irrigation systems
- General irrigation systems
- Washing plants
- Fire-fighting systems
- Pressure boosting
- Industrial plants
- Water supply systems
- Heating, ventilation and air-conditioning systems
- Marine applications

Fluids handled

- Hot water
- Clear water
- Condensate
- Cooling water
- Fire-fighting water
- Oil
- Cleaning agents
- And others (⇒ Page 9)

Operating data

Movitec A

Characteristic		Value
Flow rate	Q [m ³ /h]	≤ 8,6
	Q [l/s]	≤ 2,4
Head	H [m]	≤ 401
Fluid temperature	T [°C]	-15 to +120
Operating pressure	p [bar]	≤ 40 ¹⁾

Movitec B

Characteristic		Value
Flow rate	Q [m ³ /h]	≤ 112,8
	Q [l/s]	≤ 31,0
Head	H [m]	≤ 249
Fluid temperature	T [°C]	-20 to +140 ²⁾
Operating pressure	p [bar]	≤ 40 ¹⁾

Designation

Example: Movitec VCF 90/2-1 B

Designation key

Code	Description
Movitec	Type series
VC	Version
LH	Pump casing made of stainless steel Hydraulic system of the pump made of stainless steel
V	Pump casing made of stainless steel / grey cast iron Hydraulic system of the pump made of stainless steel
VS	Pump casing made of stainless steel / grey cast iron Hydraulic system of the pump made of stainless steel
VC	Pump casing made of grey cast iron Hydraulic system of the pump made of stainless steel
VM	Version with close-coupled motor
F	Type of connection
-	Oval flange
E ³⁾	External thread
F	Round flange
S	Round flange
T	Tri-clamp fitting
V	Victaulic coupling
90	Size, flow rate [m ³ /h] at Q _{opt} 2, 4, 6, 10, 15, 25, 40, 60, 90
2	Number of stages
-1	Blind stages
B	Generation
4)	Generation A
B	Generation B

Further information on the designation

(⇒ Page 57)

- 1) The sum of inlet pressure and shut-off head must not exceed the value indicated.
- 2) For operating temperatures > 120 °C the pressure class must not exceed PN 25.
- 3) Pumps with external thread are supplied with an integrated swing check valve as standard.
- 4) Blank

Design details

Design

- High-pressure in-line pump
- Maximum pressure class PN 40
- Centrifugal pump
- Single-stage or multi-stage

Installation types

Standard:

- Vertical installation

Optional:

- Horizontal installation

Drive

- Surface-cooled KSB squirrel-cage motor
- 3~230/400 V up to 2.2 kW
- 3~400/690 V from 3 kW
- Thermal class F to IEC 34-1
- Efficiency class IE3 (for three-phase motors ≥ 0.75 kW)
- IP55 enclosure
- Frequency 50 Hz
- Thermal class F

Shaft seal

The shaft seal is an uncooled, maintenance-free mechanical seal to EN 12756.

- "Fixed" design
 - Mechanical seal in standard design
 - Unbalanced bellows-type seal
 - ≤ 25 bar
 - Fitted as standard for Movitec 2B, 4B, 6B, 10B, 15B
- "Easy access" design
 - Easy to replace
 - Unbalanced bellows-type seal
 - ≤ 25 bar
 - Drive lantern need not be removed to replace the seal.
 - Motor rating 5.5 kW and above: Motor need not be removed.
 - Fitted as standard for Movitec 25B, 40B, 60B, 90B
- Cartridge design
 - Cartridge seal
 - Unbalanced bellows-type design (PN 25) or special balanced design (PN 40)
 - Drive lantern need not be removed to replace the seal.
 - Motor rating 5.5 kW and above: Motor need not be removed.
 - Optionally available for all sizes except Movitec LHS 6

Bearings

- Tungsten carbide plain bearings at the hydraulic rotor

Materials

Overview of materials depending on the design

Components	Movitec			
	V	VC	VS	LHS 6
Baseplate				
Grey cast iron ⁵⁾	EN-GJS-400-15/ EN-GJL-250	-	EN-GJS-400-15/ EN-GJL-250	-
Cast stainless steel ⁶⁾	1.4308	-	1.4308	-
Pump casing				
Grey cast iron ⁷⁾	-	EN-GJL-250	-	-
Cast stainless steel	1.4308	-	1.4408	1.4408
Hydraulic system of the pump				
Stainless steel	1.4301	1.4301	1.4404	1.4404
Cast stainless steel ⁸⁾	1.4308	1.4308	1.4408	-

Comparison of materials

EN	ASTM
EN-GJL-250	A48 Class 35 B
EN-GJS-400-15	A5369 Grade 60-40-18
1.4301	SS 304
1.4308	Grade CF8M
1.4404	SS 316L
1.4408	Grade CF8M

Coating and preservation

Coating of pump components

Component	Coating
Stainless steel components	No additional coating
Movitec VC:	
Pump casing made of grey cast iron	Cataphoretic coating
Movitec V/VS:	
Slide flanges made of grey cast iron	Cataphoretic coating
Drive lantern made of grey cast iron	Powder coating

Product benefits

- Reliable: product-lubricated plain bearings made of tungsten carbide, cast pump foot, torsion-resistant pump shroud and confined O-rings
- Long service life due to corrosion-resistant hydraulic components made of stainless steel
- Easy to service: Can be fitted with any standardised mechanical seal (to EN 12756)
- Various materials and connection options, extended temperature and pressure range

Product information as per Regulation No. 547/2012 (for water pumps with a maximum shaft power of 150 kW) implementing "Ecodesign" Directive 2009/125/EC

- Minimum efficiency index: see data sheet

- The benchmark for the most efficient water pumps is MEI ≥ 0.70 .
- Year of construction: see data sheet
- Manufacturer's name or trade mark, commercial registration number and place of manufacture: see data sheet or order documentation
- Product's type and size identifier: see data sheet
- Hydraulic pump efficiency (%) with trimmed impeller: see data sheet
- Pump performance curves, including efficiency characteristics: see documented characteristic curve
- The efficiency of a pump with a trimmed impeller is usually lower than that of a pump with full impeller diameter. Trimming of the impeller will adapt the pump to a fixed duty point, leading to reduced energy consumption. The minimum efficiency index (MEI) is based on the full impeller diameter.
- Operation of this water pump with variable duty points may be more efficient and economic when controlled, for example, by the use of a variable speed drive that matches the pump duty to the system.
- Information relevant for disassembly, recycling or disposal at end of life: see installation/operating manual
- Information on benchmark efficiency or benchmark efficiency graph for MEI = 0.7 (0.4) for the pump based on the model shown in the Figure are available at: <http://www.europump.org/efficiencycharts>

Acceptance tests / Warranties

- Pressure test
 - to EN 809
- Leak test
 - with water
- Materials testing
 - Certificate of compliance with the order (corresponds to EN 10204)
 - In the certificate of compliance with the order the manufacturer confirms by way of an informal report without specifying test results that the delivery complies with the stipulations of the purchase order.

5) Powder-coated

6) Optional

7) With cataphoretic coating

8) Size 90 only

- Test report 2.2 on request
- Final inspection
 - Inspection certificate 3.1 to EN 10204 on request
- Hydraulic test

The duty point of each pump is guaranteed to ISO 9906:2012 Grade 3B.
 This test is always carried out using the original motor.
 The NPSH and the suction lift are not measured (3.2 certificate available).

- Warranties
 Warranties are given within the scope of the valid delivery conditions.

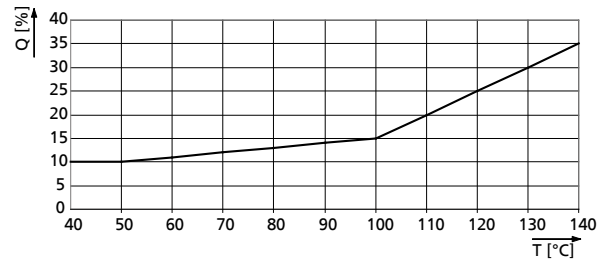

Minimum flow rate required as a function of fluid temperature at a fluid temperature > +20 °C

Selection information

Information about the characteristic curve

NPSH:

- The NPSH values given in the individual characteristic curves are minimum values which correspond to the cavitation limit.
- A safety margin of at least 0.5 m must be added when selecting the pump to compensate for measuring inaccuracies.
- The NPSH curves reflect average values.
- A safety margin of 0.5 m must be added to the NPSH value of the characteristic curve when selecting a system.

Fluid handled

The actual operating conditions must always be checked (concentration, temperature, solids content). Penetration of air into the system must be avoided by all means.

If the fluid handled contains solids such as steel chips or steel chip dust, check the permissible particle concentration with KSB.

Minimum/maximum flow rate

Minimum/maximum flow rate Q at a fluid temperature ≤ +20 °C

Movitec	Q			
	2 poles		4 poles	
	min. [m³/h]	max. [m³/h]	min. [m³/h]	max. [m³/h]
2B	0,2	3,3	-	-
4B	0,4	6,5	-	-
6B	0,6	9,0	-	-
10B	1,1 ⁹⁾	13,2	0,5	6,6
15B	1,6 ⁹⁾	22,5	0,8	11,3
25B	2,8	35,0	1,4	17,5
40B	4,0	54,0	2,0	27,0
60B	6,0	76,0	3,0	38,0
90B	8,5	110,0	4,3	53,9
LHS 6	0,8	8,6	-	-

⁹⁾ For pumps with VdS certification, the minimum flow rate Q min is 5 % of the permissible flow rate.

Programme overview / selection tables

Table of fluids handled

The data refer to the chemical resistance of the materials. The relevant regulations / standards governing individual pump applications have to be complied with.

If the operating conditions differ from the data given (e.g. mixed products) or if the fluids handled are not included in the table below, please contact KSB.

- **Temperature ranges:**
 - Reference temperature: +20 °C
 - For temperatures <0 °C: contact KSB.
 - For temperatures > +50 °C: check and observe the vapour pressure of the fluid handled.
 - Max. temperature = +120 °C, unless indicated otherwise.
- Max. concentration = 100 % unless indicated otherwise.
- Mechanical seal silicon carbide / carbon (Q1B): not suitable for fluids containing solid substances. This rule also covers particles developing as a result of salt crystallisation at low fluid temperatures.
- Mechanical seal tungsten carbide / tungsten carbide (U3U3): solids content max. 20 ppm (depending on particle size), with the exception of corrosive fluids. Fluids with a higher solids content are not permitted (ppm = 1 mg/kg).
- Caution: High temperatures will increase corrosion (reference temperature = +20 °C).
- Under unfavourable conditions (high temperatures, deposits, long idle periods), chloride contents of more than 300 mg/l may result in localised corrosion.

Selecting the design of pump and mechanical seal depending on the fluid to be handled

Fluid handled			Movitec																	
Substance contained	Max. per-centage	T _{max.}	V					VC					VS					LHS		
	[%]	[°C]	13	14	15	16	18	13	14	15	16	18	23	13	14	15	16	18	17	19
Alum, acid-free	≤ 3	+50	-	X	-	-	-	-	-	-	-	-	-	-	X	-	-	-	-	-
Alum, acid-free	≤ 3	+80	-	-	-	-	-	-	-	-	-	-	-	-	X	-	-	-	-	-
Alkaline solution, bottle rinsing, max. 2 % sodium hydroxide	≤ 100	+40	-	-	X	-	-	-	-	X	-	-	-	-	-	X	-	-	-	-
Alcohol																				
▪ Butanol	≤ 100	+60	X	-	-	-	-	X	-	-	-	-	X	X	-	-	-	-	-	-
▪ Ethanol	≤ 100	+60	X	-	-	-	-	X	-	-	-	-	X	X	-	-	-	-	-	-
▪ Propanol	≤ 100	+80	X	-	-	-	-	X	-	-	-	-	X	X	-	-	-	-	-	-
▪ Spirits (40 % ethanol)	≤ 100	+60	X	-	-	-	-	-	-	-	-	-	-	X	-	-	-	-	-	-
Wine (white, red)	≤ 100	+60	X	X	-	-	-	-	-	-	-	-	-	X	X	-	-	-	X	X
Tartaric acid	≤ 100	+60	-	-	-	-	-	-	-	-	-	-	-	-	-	-	-	-	X	-
Ammonium bicarbonate	≤ 10	+40	X	-	-	-	-	X	-	-	-	-	X	X	-	-	-	-	-	-
Aluminium sulphate, acid-free	≤ 5	+50	-	-	-	X	-	-	-	-	-	-	-	-	-	-	X	-	-	-
Aluminium sulphate, acid-free	≤ 5	+60	-	-	-	-	-	-	-	-	-	-	-	-	-	-	X	-	-	-
Ammonium sulphate	≤ 20	+60	X	-	-	-	-	-	-	-	-	-	-	X	-	-	-	-	-	-
Calcium acetate, acid-free	≤ 10	+60	X	-	-	-	-	X	-	-	-	-	X	X	-	-	-	-	-	-
Calcium nitrate, acid-free	≤ 10	+60	-	-	-	X	-	-	-	-	-	-	-	-	-	-	X	-	-	-
Ferric sulphate (II)	≤ 5	+80	-	-	-	X	-	-	-	-	-	-	-	-	-	-	X	-	-	-
Water-oil emulsion (95 %, 5 %), free of solids	≤ 100	+80	-	X	-	-	-	-	X	-	-	-	-	-	X	-	-	-	-	-
Ethylene glycol base anti-freeze, inhibited, closed system	≤ 20	+110	X ¹⁰⁾	X	-	X	-	X ¹⁰⁾	X	-	X	-	X ¹⁰⁾	X ¹⁰⁾	X	-	X	-	-	-
	≤ 25	+110	X ¹⁰⁾	X	-	X	-	X ¹⁰⁾	X	-	X	-	X ¹⁰⁾	X ¹⁰⁾	X	-	X	-	-	-
	≤ 30	+110	X ¹⁰⁾	X	-	X	-	X ¹⁰⁾	X	-	X	-	X ¹⁰⁾	X ¹⁰⁾	X	-	X	-	-	-
	≤ 35	+110	X ¹⁰⁾	X	-	X	-	X ¹⁰⁾	X	-	X	-	X ¹⁰⁾	X ¹⁰⁾	X	-	X	-	-	-
	≤ 40	+110	X ¹⁰⁾	X	-	X	-	X ¹⁰⁾	X	-	X	-	X ¹⁰⁾	X ¹⁰⁾	X	-	X	-	-	-
	≤ 45	+110	X ¹⁰⁾	X	-	X	-	X ¹⁰⁾	X	-	X	-	X ¹⁰⁾	X ¹⁰⁾	X	-	X	-	-	-
Ethylene glycol base anti-freeze, inhibited, open system	≤ 20	+110	X ¹⁰⁾	X	-	X	-	-	-	-	-	-	-	X ¹⁰⁾	X	-	X	-	-	-
	≤ 25	+110	X ¹⁰⁾	X	-	X	-	-	-	-	-	-	-	X ¹⁰⁾	X	-	X	-	-	-
	≤ 30	+110	X ¹⁰⁾	X	-	X	-	-	-	-	-	-	-	X ¹⁰⁾	X	-	X	-	-	-
	≤ 35	+110	X ¹⁰⁾	X	-	X	-	-	-	-	-	-	-	X ¹⁰⁾	X	-	X	-	-	-

10) ≤ 100 °C

Fluid handled			Movitec																		
Substance contained	Max. per-centage	T _{max.}	V					VC						VS					LHS		
			[%]	[°C]	13	14	15	16	18	13	14	15	16	18	23	13	14	15	16	18	17
	≤ 40	+110	X ¹⁰⁾	X	-	X	-	-	-	-	-	-	-	-	X ¹⁰⁾	X	-	X	-	-	-
	≤ 45	+110	X ¹⁰⁾	X	-	X	-	-	-	-	-	-	-	-	X ¹⁰⁾	X	-	X	-	-	-
	≤ 50	+110	X ¹⁰⁾	X	-	X	-	-	-	-	-	-	-	-	X ¹⁰⁾	X	-	X	-	-	-
Glycerine	≤ 40	+80	X	X	-	-	-	X	X	-	-	-	X	X	X	X	-	-	-	-	-
Glycols (pure)	≤ 100	+100	-	-	-	-	-	-	-	-	-	-	-	-	-	-	-	-	-	-	-
Diethylene glycol	≤ 100	+100	X	X	-	-	-	X	X	-	-	-	X	X	X	X	-	-	-	-	-
Ethylene glycol	≤ 100	+100	X	X	-	-	-	X	X	-	-	-	X	X	X	X	-	-	-	-	-
Potassium hydroxide	≤ 5	+40	-	-	X	-	-	-	X	-	-	-	-	-	-	X	-	-	-	-	-
Potassium nitrate, acid-free	≤ 5	+30	-	-	X	-	-	-	X	-	-	-	-	-	-	X	-	-	-	-	-
Potassium sulphate, acid-free	≤ 3	+20	-	X	-	-	-	-	X	-	-	-	-	-	-	X	-	-	-	-	-
Copper sulphate	≤ 5	+80	-	-	X	-	-	-	-	-	-	-	-	-	-	-	X	-	-	-	-
Magnesium sulphate	≤ 10	+80	-	X	-	-	-	-	-	-	-	-	-	-	-	X	-	-	-	X	-
Milk	≤ 100	+60	X	X	-	-	-	-	-	-	-	-	-	X	X	-	-	-	-	-	-
Lactic acid	≤ 40	+60	-	-	-	-	-	-	-	-	-	-	-	-	-	-	-	-	-	X	-
Miscella ¹¹⁾	≤ 100	+40	-	-	-	-	-	-	-	-	-	-	-	-	-	-	-	-	-	-	-
Sodium carbonate	≤ 6	+60	X	-	-	-	-	X	-	-	-	-	X	X	-	-	-	-	-	-	X
Sodium hydroxide	≤ 5	+60	-	-	X	-	-	-	X	-	-	X	-	-	-	-	X	-	-	-	-
Sodium nitrate, acid-free	≤ 10	+30	X	-	-	-	-	X	-	-	-	-	X	X	-	-	-	-	-	-	X
Sodium nitrate, acid-free	≤ 10	+60	X	-	-	-	-	X	-	-	-	-	-	-	-	-	-	-	-	-	X
Sodium sulphate, acid-free	≤ 5	+60	X	-	-	-	-	-	-	-	-	-	-	X	-	-	-	-	-	-	X
Oil																					
▪ Peanut oil	≤ 100	+90	-	X	-	-	-	-	X	-	-	-	-	-	-	X	-	-	-	-	-
▪ Peanut oil	≤ 100	+100	-	-	-	-	-	-	-	-	-	-	-	-	-	-	-	-	-	X	-
▪ Linseed oil, ≤ 3 % H ₂ SO ₄	≤ 100	+20	-	X	-	-	-	-	-	-	-	-	-	-	-	X	-	-	-	-	-
▪ Linseed oil, ≤ 3 % H ₂ SO ₄	≤ 100	+60	-	-	-	-	-	-	-	-	-	-	-	-	-	X	-	-	-	-	-
▪ Hydraulic oil ¹¹⁾	≤ 100	+80	-	-	-	-	-	-	-	-	-	-	-	-	-	-	-	-	-	X	-
▪ Linseed oil	≤ 100	+60	-	X	-	-	-	-	X	-	-	-	-	-	-	X	-	-	-	-	-
▪ Linseed oil	≤ 100	+60	-	-	-	-	-	-	-	-	-	-	-	-	-	-	-	-	-	X	-
▪ Corn oil	≤ 100	+100	-	X	-	-	-	-	X	-	-	-	-	-	-	X	-	-	-	X	-
▪ Mineral oil ¹¹⁾	≤ 100	+80	-	-	-	-	-	-	-	-	-	-	-	-	-	-	-	-	-	X	-
▪ Vegetable oil ¹¹⁾	≤ 100	+100	-	-	-	-	-	-	-	-	-	-	-	-	-	-	-	-	-	X	-
▪ Rapeseed oil	≤ 100	+100	-	X	-	-	-	-	X	-	-	-	-	-	-	X	-	-	-	X	-
▪ Salad oil	≤ 100	+100	-	-	-	-	-	-	-	-	-	-	-	-	-	-	-	-	-	X	-
▪ Lubricating oil ¹¹⁾	≤ 100	+100	-	-	-	-	-	-	-	-	-	-	-	-	-	-	-	-	-	X	-
▪ Silicone oil ¹¹⁾	≤ 100	+60	-	-	-	-	-	-	-	-	-	-	-	-	-	-	-	-	-	X	-
▪ Soybean oil	≤ 100	+100	-	X	-	-	-	-	X	-	-	-	-	-	-	X	-	-	-	X	-
▪ Turpentine oil ¹¹⁾	≤ 100	+60	-	-	-	-	-	-	-	-	-	-	-	-	-	-	-	-	-	X	-
▪ Turbine oil (no SDF oils) ¹¹⁾	≤ 100	+100	-	-	-	-	-	-	-	-	-	-	-	-	-	-	-	-	-	X	-
▪ Oil-water mixtures	≤ 100	+100	-	-	-	-	-	-	-	-	-	-	-	-	-	-	-	-	-	X	-
Paraffin ¹¹⁾	≤ 100	+100	-	-	-	-	-	-	-	-	-	-	-	-	-	-	-	-	-	X	-
Kerosene	≤ 100	+80	-	X	-	-	-	-	-	-	-	-	-	-	-	X	-	-	-	X	-
Polyethylene glycol ¹¹⁾	≤ 100	+80	-	-	-	-	-	-	-	-	-	-	-	-	-	-	-	-	-	X	X
Polyglycol ¹¹⁾	≤ 100	+80	-	-	-	-	-	-	-	-	-	-	-	-	-	-	-	-	-	X	-
Crude oil ¹¹⁾	≤ 100	+80	-	-	-	-	-	-	-	-	-	-	-	-	-	-	-	-	-	X	-
Crude oil condensate ¹¹⁾	≤ 100	+80	-	-	-	-	-	-	-	-	-	-	-	-	-	-	-	-	-	X	-
Juice (fruit and sugar juice)	≤ 100	+60	-	X	-	-	-	-	-	-	-	-	-	-	-	X	-	-	-	X	-
Acid																					
▪ Acetic acid	≤ 10	+60	X	-	-	-	-	-	-	-	-	-	-	X	-	-	-	-	-	-	-
▪ Acetic acid	≤ 5	+60	X	-	-	-	-	-	-	-	-	-	-	X	-	-	-	-	-	-	-
▪ Tannic acid	≤ 20	+80	-	X	-	-	-	-	-	-	-	-	-	-	X	-	-	-	-	-	-
▪ Maleic acid	≤ 10	+60	-	X	-	-	-	-	-	-	-	-	-	-	X	-	-	-	-	-	-
▪ Lactic acid	≤ 5	+60	-	X	-	-	-	-	-	-	-	-	-	-	X	-	-	-	-	-	-
▪ Lactic acid	≤ 40	+60	-	X	-	-	-	-	-	-	-	-	-	-	X	-	-	-	-	-	-
▪ Phosphoric acid	≤ 5	+20	-	X	-	-	-	-	-	-	-	-	-	-	X	-	-	-	-	-	-
▪ Sulphuric acid	≤ 5	+20	-	-	-	-	-	-	-	-	-	-	-	-	-	-	X	-	-	-	-
▪ Tartaric acid	≤ 8	+40	-	-	-	-	-	-	-	-	-	-	-	-	X	-	-	-	-	-	-

11) Fluid details are required in this case.

Fluid handled			Movitec																				
Substance contained	Max. per-centage	T _{max.}	V					VC						VS					LHS				
			[%]	[°C]	13	14	15	16	18	13	14	15	16	18	23	13	14	15	16	18	17	19	
▪ Citric acid	≤ 25	+30	-	X	-	-	-	-	-	-	-	-	-	-	-	-	X	-	-	-	-	-	
▪ Citric acid	≤ 10	+30	-	X	-	-	-	-	-	-	-	-	-	-	-	-	X	-	-	-	-	-	
Fuel																							
▪ Diesel oil	≤ 100	+80	-	X	-	-	-	-	-	-	-	-	-	-	-	-	X	-	-	-	-	-	
▪ Fuel oil	≤ 100	+80	-	X	-	-	-	-	-	-	-	-	-	-	-	-	X	-	-	-	-	-	
▪ Kerosene (jet fuel)	≤ 100	+80	-	X	-	-	-	-	-	-	-	-	-	-	-	-	X	-	-	-	-	-	
Trisodium phosphate	≤ 4	+80	-	-	X	-	-	-	-	X	-	-	-	-	-	-	-	X	-	-	-	-	
Water																							
▪ Deionised water (fully desalinated)	≤ 100	+140	X	-	-	-	X ¹²⁾	-	-	-	-	-	-	-	-	X	-	-	-	X ¹²⁾	-	X	
▪ Distilled water	≤ 100	+140	-	-	-	-	-	-	-	-	-	-	-	-	-	-	-	-	-	-	-	X ¹³⁾	
▪ Dealkalised water	≤ 100	+120	-	-	X	-	-	-	-	-	-	-	-	-	-	-	X	-	-	-	-	-	
▪ Decarbonised water	≤ 100	+120	-	-	X	-	-	-	-	-	-	-	-	-	-	-	X	-	-	-	-	-	
▪ Swimming pool water (no brine)	≤ 100	+100	-	-	-	-	-	-	-	-	-	-	-	-	-	-	-	-	-	-	X	-	
▪ Permeate (osmosis)	≤ 100	+140	X	-	-	-	X ¹²⁾	-	-	-	-	-	-	-	-	X	-	-	-	X ¹²⁾	-	-	
▪ Partly desalinated water	≤ 100	+120	-	-	X	-	-	-	-	-	-	-	-	-	-	-	X	-	-	-	-	-	
▪ Fire-fighting water	≤ 100	+60	-	-	X	-	X	-	X	-	-	X	-	-	-	-	X	-	X	-	X	-	
▪ Heating water in accordance with VDI 2035	≤ 100	+100	X	-	-	-	X	X	-	-	-	X	X	X	X	-	-	-	-	X	-	X ¹³⁾	
▪ Hot water treated in accordance with VdTÜV 1466	≤ 100	+140	X ¹⁰⁾	-	-	-	X ¹²⁾	X ¹⁰⁾	-	-	-	X ¹²⁾	X ¹⁰⁾	X ¹⁰⁾	X ¹⁰⁾	-	-	-	-	X ¹²⁾	-	X ¹³⁾	
▪ Boiler feed water to VdTÜV 1466	≤ 100	+140	X ¹⁰⁾	-	-	-	X ¹²⁾	X ¹⁰⁾	-	-	-	X ¹²⁾	X ¹⁰⁾	X ¹⁰⁾	X ¹⁰⁾	-	-	-	-	X ¹²⁾	-	X ¹³⁾	
▪ Condensate treated in acc. with VdTÜV 1466	≤ 100	+140	X ¹⁰⁾	-	-	-	X ¹²⁾	X ¹⁰⁾	-	-	-	X ¹²⁾	X ¹⁰⁾	X ¹⁰⁾	X ¹⁰⁾	-	-	-	-	X ¹²⁾	-	X ¹³⁾	
▪ Vapour condensate (brewery)	≤ 100	+140	X ¹⁰⁾	-	-	-	X ¹²⁾	X ¹⁰⁾	-	-	-	X ¹²⁾	X ¹⁰⁾	X ¹⁰⁾	X ¹⁰⁾	-	-	-	-	X ¹²⁾	-	-	
▪ Cooling water	≤ 100	+100	-	-	-	X	-	-	-	-	X	-	-	-	-	-	-	-	X	-	-	-	
▪ Tap water	≤ 100	+60	X	-	-	-	-	X	-	-	-	-	-	-	-	X	-	-	-	-	-	-	
▪ Brewing water	≤ 100	+60	X	-	-	-	-	X	-	-	-	-	-	-	-	X	-	-	-	-	-	-	
▪ Ice water (brewery)	≤ 100	+60	X	-	-	-	-	X	-	-	-	-	-	-	-	X	-	-	-	-	-	-	
▪ Drinking water / tap water	≤ 100	+60	X	-	-	-	-	X	-	-	-	-	-	-	-	X	-	-	-	-	-	X	
▪ Hot water (brewery)	≤ 100	+60	X	-	-	-	-	X	-	-	-	-	-	-	-	X	-	-	-	-	-	-	
▪ Clean water	≤ 100	+60	X	X	X	X	X	X	X	X	X	X	X	X	X	X	X	X	X	X	X	X	-
▪ Brackish water	≤ 100	+15	-	-	-	-	-	-	-	-	-	-	-	-	-	-	-	-	-	X	-	-	
▪ Seawater	≤ 100	+15	-	-	-	-	-	-	-	-	-	-	-	-	-	-	-	-	-	X	-	-	
▪ Raw water	≤ 100	+60	-	-	X	-	-	-	-	X	-	-	-	-	-	-	-	X	-	-	-	-	
▪ Grey water, slightly contaminated water	≤ 100	+60	-	-	X	-	-	-	-	X	-	-	-	-	-	-	-	X	-	-	-	-	
▪ River water	≤ 100	+60	-	-	X	-	-	-	-	X	-	-	-	-	-	-	-	X	-	-	-	-	
▪ Lake water	≤ 100	+60	-	-	X	-	-	-	-	X	-	-	-	-	-	-	-	X	-	-	-	-	
▪ Dam water	≤ 100	+60	-	-	X	-	-	-	-	X	-	-	-	-	-	-	-	X	-	-	-	-	
▪ Surface water	≤ 100	+60	-	-	X	-	-	-	-	X	-	-	-	-	-	-	-	X	-	-	-	-	
▪ Fresh water	≤ 100	+60	-	X	-	-	-	-	X	-	-	-	-	-	-	-	X	-	-	-	-	-	
▪ Barrier water	≤ 100	+70	-	-	-	X	-	-	-	-	-	X	-	-	-	-	-	-	X	-	-	-	
▪ Rinsing water	≤ 100	+70	-	-	-	X	-	-	-	-	-	X	-	-	-	-	-	-	X	-	-	-	
▪ Rainwater, with strainer	≥ 20	+60	-	-	-	X	-	-	-	-	-	X	-	-	-	-	-	-	X	-	-	-	
▪ Water-glycol mixture	≤ 100	+100	-	-	-	-	-	-	-	-	-	-	-	-	-	-	-	-	-	-	-	X	

12) ≤ 120 °C, depending on the pressure classes

13) ≤ 120 °C

Shaft seal

Available mechanical seals

Mechanical seal							T		p
Code	Type	Code to EN 12756	Elastomer	Version			min.	max.	[bar]
				C	E	F	[°C]	[°C]	
11	MG-G60	B Q1 E G G	EPDM	X	X	X	-20	+100	10
12	MG-G60	B Q1 V G G	FPM	X	X	X	-20	+120	10
13	RMG-G606	Q1 B E G G	EPDM WRAS / ACS	X	X	X	-20	+100	25
14	RMG-G606	Q1 B V G G	FPM	X	X	X	-20	+120	25
15	RMG-G606	U3 U3 X4 G G	HNBR	X	X	X	-20	+120 ¹⁴⁾	25
16	RMG-G606	U3 U3 V G G	FPM	X	X	X	-20	+120 ¹⁴⁾	25
17	M37GN2/16-00-R	U3 B V G G	FPM	-	-	X	-20	+120	40
18	RMG-G606	U3 B E G G	EPDM 559236	X	X	X	-20	+120 ¹⁴⁾	25
19	M37GN2/16-00-R	U3 B E G G	EPDM	-	-	X	-20	+120	40
20	H7N	Q1 A E G G	EPDM 559236	X	-	-	-20	+120 ¹⁵⁾	40
21	H7N	Q1 A V G G	FPM	X	-	-	-20	+120 ¹⁵⁾	40
22	H7N	Q1 A X4 G G	HNBR	X	-	-	-20	+120 ¹⁵⁾	40
23	RMG-G606	Q1 B E G G	EPDM	X	X	X	-20	+100	25
24	MG-G606	Q1 Q1 V G G	FPM	X	X	X	-20	+120	10
28	MG-G606	Q1 Q1 X4 G G	HNBR	X	X	X	-20	+120	10
29	MG-G606	Q1 Q1 E G G	EPDM	X	X	X	-20	+100	10

Key to mechanical seal materials

Description	Code to EN 12756	Contact face materials / secondary seals
Primary ring	B	Hard carbon, resin-impregnated
	U3	Tungsten carbide (CrNiMo binder)
	Q1	Silicon carbide (sintered without pressure)
Mating ring	A	Carbon graphite, antimony-impregnated
	B	Hard carbon, resin-impregnated
	U3	Tungsten carbide (CrNiMo binder)
	Q1	Silicon carbide (sintered without pressure)
Elastomer	E	EPDM (ethylene propylene rubber)
	V	Fluoroelastomer (FPM)
	X4	HNBR
Spring	G	CrNiMo steel
Other metal parts	G	CrNiMo steel

¹⁴⁾ Up to 140 °C if the pressure does not exceed 16 bar

¹⁵⁾ Up to 140 °C if the pressure does not exceed 25 bar

Pressure and temperature limits

Movitec A, B

Movitec A

Pressure and temperature limits

Movitec	p	T
	[bar]	[°C]
LHS6	40	120

Movitec B

The pump's pressure and temperature limits are indicated on the name plate.

Material variants

Overview of pump component materials depending on the design

Part No.	Description	Movitec			
		V	VC	VS	LHS 6
10-6	Pump shroud	1.4301		1.4404	
101	Pump casing	1.4308	EN-GJL-250	1.4408	
108	Stage casing	1.4301 ¹⁶⁾ / 1.4308 ¹⁷⁾		1.4404 ¹⁶⁾ / 1.4408 ¹⁷⁾	
160	Discharge cover	1.4301 ¹⁶⁾ / 1.4308 ¹⁷⁾		1.4404 ¹⁶⁾ / 1.4408 ¹⁷⁾	
210	Shaft	1.4057		1.4460	
230	Impeller	1.4301 ¹⁶⁾ / 1.4308 ¹⁷⁾		1.4404 ¹⁶⁾ / 1.4408 ¹⁷⁾	
341	Drive lantern	EN-GJL-250 ¹⁸⁾ / EN-GJS-400-15 ¹⁹⁾			
412	O-ring	EPDM-WRc / ACS / ACS	EPDM	FPM / HNBR	
525	Spacer sleeve	1.4301		1.4401	
529	Bearing sleeve	Tungsten carbide / aluminium oxide			
890	Baseplate	EN-GJS-400-15 / EN-GJL-250 / 1.4308 ²⁰⁾	-	EN-GJS-400-15 / EN-GJL-250 / 1.4308 ²⁰⁾	
905	Tie bolt	1.4057			
920	Nut	1.4301		1.4404	
932	Circlip	1.4571			

Comparison of materials

EN	ASTM
EN-GJL-250	A48 Class 35 B
EN-GJS-400-15	A5369 Grade 60-40-18
1.4057	SS 431
1.4301	SS 304
1.4308	Grade CF8M
1.4404	SS 316L
1.4408	Grade CF8M
1.4460	SS 329
1.4571	SS 316Ti

¹⁶⁾ Movitec 2B, 4B, 6B, 10B, 15B, 25B, 40B, 60B

¹⁷⁾ Movitec 90B

¹⁸⁾ Movitec 2B, 4B, 6B, 10B, 15B, 25B (≤ 4 kW) and Movitec 90B

¹⁹⁾ Movitec 2B, 4B, 6B, 10B, 15B, 25B (≥ 5.5 kW) and Movitec 40B, 60B

²⁰⁾ Optional for: Movitec 2B, 4B, 6B, 10B, 15B

Technical data

Motors

- Efficiency class IE3 (for three-phase motors ≥ 0.75 kW)

Technical data of the motors

P_N	U_N	I_A	I_A/I_N	$\cos \varphi$	Tolerance U_N	n	η	L_p	Cable gland	Maximum frequency of starts
[kW]	[V]	[A]			[%]	rpm	[%]	[dB]		$1/h$
0,37	1 × 230	2,6	3,7	0,92	+/-10	2750	67,00	58	1 × M18 × 1,5	20
0,55	1 × 230	3,69	3,9	0,92	+/-10	2760	70,00	56	1 × M18 × 1,5	20
0,75	1 × 230	5	3,9	0,92	+/-10	2780	70,00	56	1 × M20 × 1,5	20
1,1	1 × 230	6,68	4,3	0,95	+/-10	2790	75,00	58	1 × M20 × 1,5	20
1,5	1 × 230	8,99	4,8	0,95	+/-10	2800	76,00	58	1 × M20 × 1,5	20
2,2	1 × 230	13,04	4,8	0,95	+/-10	2800	77,00	58	1 × M20 × 1,5	20
0,37	230/400	1,64/0,94	4,6	0,78	+/-10	2750	74,20	58	1 × M20 × 1,5	20
0,55	230/400	2,31/1,33	5,2	0,75	+/-10	2790	77,60	58	1 × M20 × 1,5	20
0,75	230/400	2,92/1,68	6,8	0,8	+/-10	2855	80,50	60	2 × M20 × 1,5	25
1,1	230/400	4,17/2,4	7	0,8	+/-10	2855	82,70	60	2 × M25 × 1,5	25
1,5	230/400	5,08/2,92	7,7	0,88	+/-10	2900	84,20	63	2 × M25 × 1,5	25
2,2	230/400	7,22/4,15	7,7	0,89	+/-10	2900	86,00	63	2 × M25 × 1,5	25
3	230/400	9,71/5,59	8,8	0,89	+/-10	2910	87,10	63	2 × M25 × 1,5	20
3	400/690	5,59/3,24	8,8	0,89	+/-10	2910	87,10	63	2 × M25 × 1,5	20
4	230/400	13,0/7,45	8,5	0,88	+/-10	2910	88,10	63	2 × M25 × 1,5	20
4	400/690	7,45/4,32	8,5	0,88	+/-10	2910	88,10	63	2 × M25 × 1,5	20
5,5	230/400	17,4/10,0	8,8	0,89	+/-10	2925	89,20	68	2 × M32 × 1,5	20
5,5	400/690	10,0/5,80	8,8	0,89	+/-10	2925	89,20	68	2 × M32 × 1,5	20
7,5	230/400	23,2/13,4	8,8	0,9	+/-10	2925	89,80	68	2 × M32 × 1,5	20
7,5	400/690	13,4/7,74	8,8	0,9	+/-10	2925	89,80	68	2 × M32 × 1,5	20
11	230/400	33,6/19,3	8	0,9	+/-10	2940	91,20	68	2 × M32 × 1,5	15
11	400/690	19,3/11,2	8	0,9	+/-10	2940	91,20	68	2 × M32 × 1,5	15
15	230/400	45,5/26,2	8	0,9	+/-10	2940	91,90	68	2 × M32 × 1,5	15
15	400/690	26,2/15,2	8	0,9	+/-10	2940	91,90	68	2 × M32 × 1,5	15
18,5	230/400	55,2/31,8	8	0,91	+/-10	2945	92,40	68	2 × M32 × 1,5	15
18,5	400/690	31,8/18,4	8	0,91	+/-10	2945	92,40	68	2 × M32 × 1,5	15
22	230/400	65,5/37,6	8,5	0,91	+/-10	2955	92,70	70	2 × M32 × 1,5	15
22	400/690	37,6/21,8	8,5	0,91	+/-10	2955	92,70	70	2 × M32 × 1,5	15
30	230/400	89,7/51,6	8,5	0,9	+/-10	2965	93,30	73	2 × M32 × 1,5	15
30	400/690	51,6/29,9	8,5	0,9	+/-10	2965	93,30	73	2 × M50 × 1,5	15
37	230/400	110/63,3	8,5	0,9	+/-10	2965	93,70	73	2 × M50 × 1,5	15
37	400/690	63,3/36,7	8,5	0,9	+/-10	2965	93,70	73	2 × M50 × 1,5	15
45	230/400	134/76,8	8,5	0,9	+/-10	2970	94,00	75	2 × M50 × 1,5	15
45	400/690	76,8/44,5	8,5	0,9	+/-10	2970	94,00	75	2 × M50 × 1,5	15
0,55	230/400	2,34/1,34	5,3	0,73	+/-10	1425	80,70	57	1 × M20 × 1,5	20
0,75	230/400	3,13/1,8	6,5	0,73	+/-10	1425	82,50	57	1 × M20 × 1,5	20
1,1	230/400	4,21/2,42	6,5	0,78	+/-10	1440	84,40	58	1 × M20 × 1,5	20
1,5	230/400	5,59/3,21	7	0,79	+/-10	1440	85,30	58	1 × M25 × 1,5	20
2,2	230/400	7,86/4,52	7,5	0,81	+/-10	1445	86,70	59	2 × M25 × 1,5	20
3	230/400	10,6/6,10	7,5	0,81	+/-10	1445	87,70	59	2 × M25 × 1,5	20
3	400/690	6,10/3,53	7,5	0,81	+/-10	1445	87,70	59	2 × M25 × 1,5	20
4	230/400	14,0/8,05	8,5	0,81	+/-10	1450	88,50	60	2 × M25 × 1,5	20
4	400/690	8,05/4,66	8,5	0,81	+/-10	1450	88,60	60	2 × M25 × 1,5	20
5,5	230/400	19,0/10,9	8,5	0,81	+/-10	1460	89,90	60	2 × M32 × 1,5	20
5,5	400/690	10,9/6,34	8,5	0,81	+/-10	1460	89,60	60	2 × M32 × 1,5	20
7,5	230/400	25,4/14,6	8,5	0,82	+/-10	1460	90,40	60	2 × M32 × 1,5	20
7,5	400/690	14,6/8,47	8,5	0,82	+/-10	1460	90,40	60	2 × M32 × 1,5	20

Types of connection

Overview of available connection types

Description	Movitec								
	V/VS	VF	VSF ²¹⁾	VCF	LHS	VE/VME ²¹⁾	VV/MMV/VS	VT/VST/VMT ²¹⁾	
Type of connection	Oval flange	Round flange				External thread	Victaulic coupling	Tri-clamp fitting	
Standard	ISO 228-1	EN 1092-1/EN 1092-2 ASME B 16.1 JIS				EN1092-2	ISO 228-1	-	DIN 32676
Material	1.4308 ²²⁾ / 1.4408 ²³⁾	EN-GJS-400-15	1.4308	EN-GJL-250	1.4408	EN-GJS-400-15	1.4408	1.4408	
Max. pressure class	PN 16	PN 40				PN 40	PN 16	PN 40	PN 40

Terminal box positions

Top view of terminal box positions

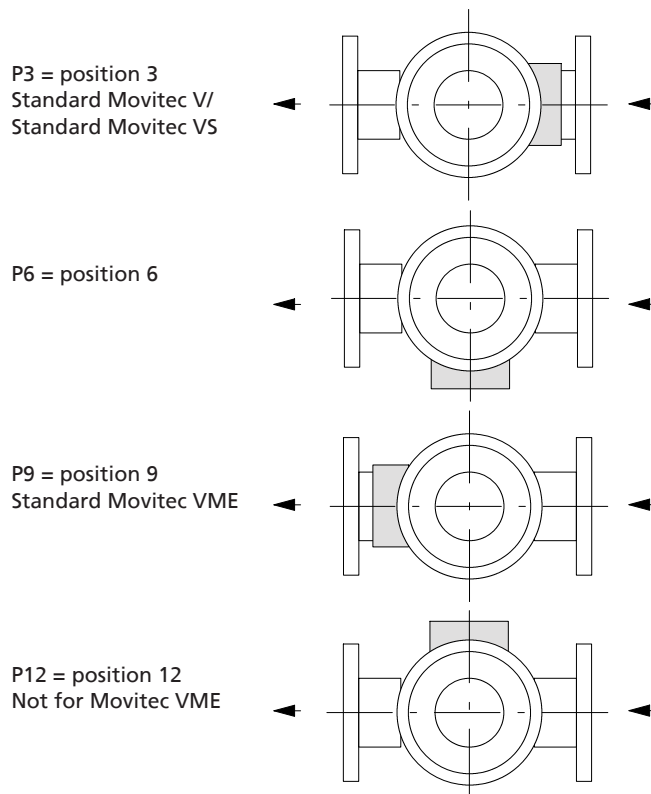

²¹⁾ The stainless steel baseplate (see illustration) is available as an option.

²²⁾ For Movitec V

²³⁾ For Movitec VS

Selection charts

Movitec; n = 2900 rpm

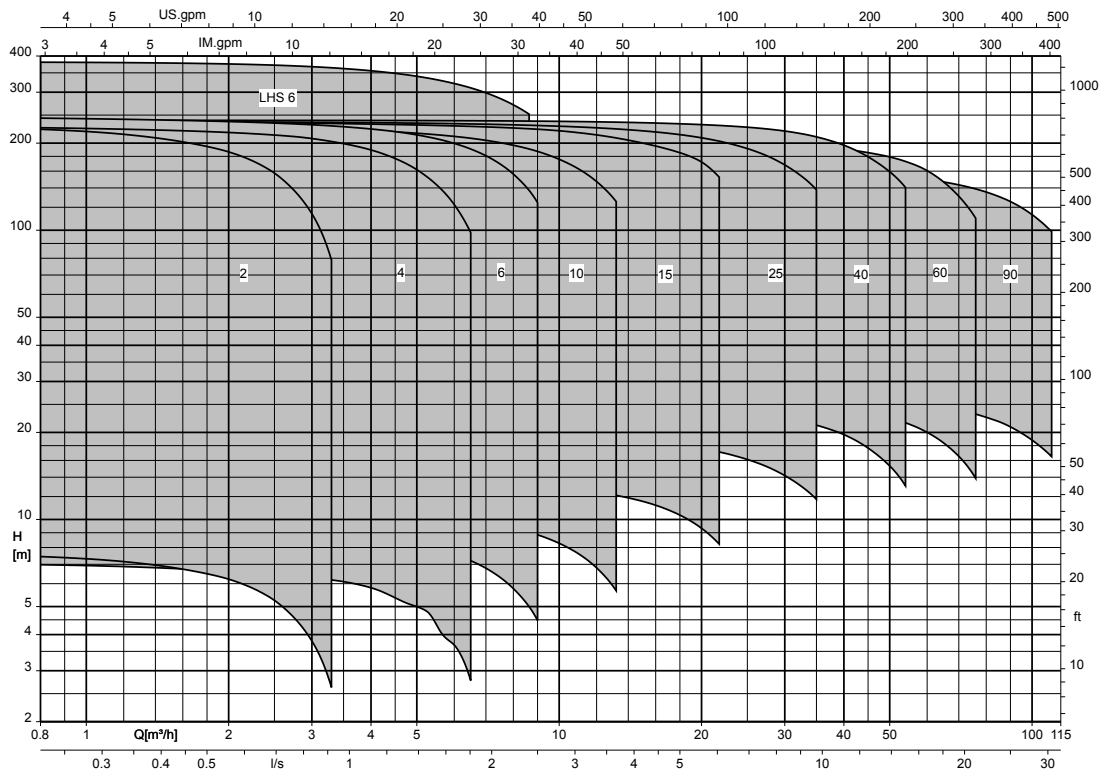

Movitec; n = 1450 rpm

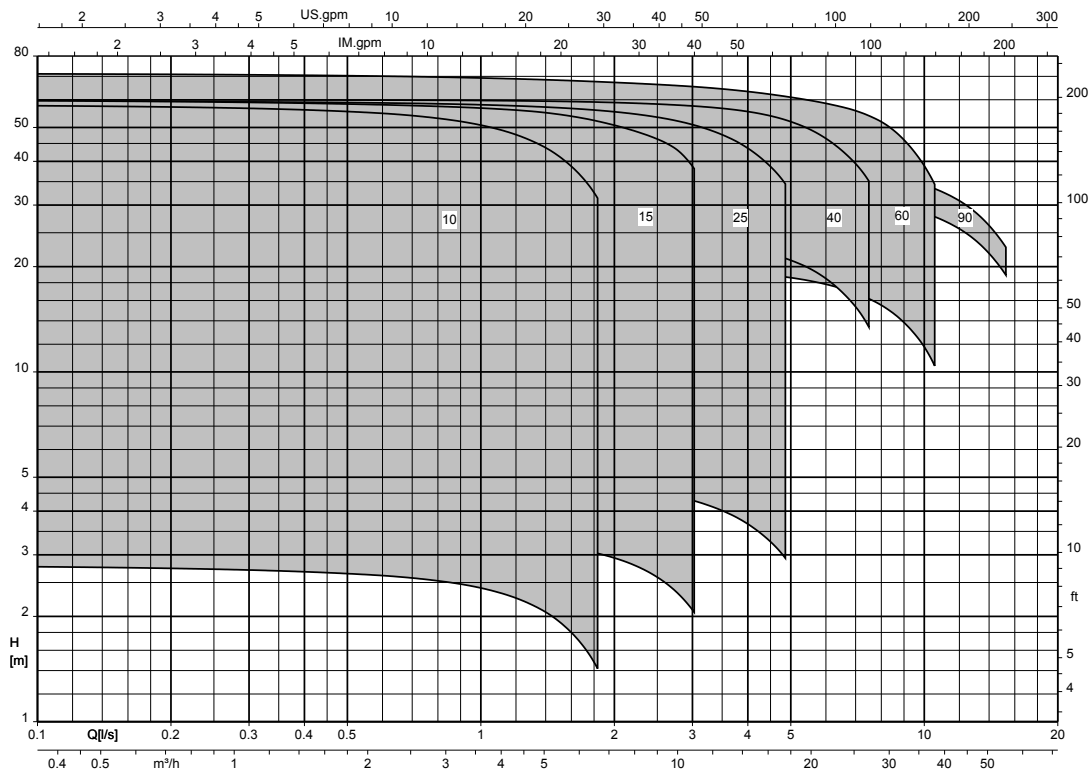

Characteristic curves

The characteristic curves are based on the following principles:

- Tolerances to ISO 9906:2012 Grade 3B

The characteristic curves were measured under the following conditions:

- Motor used:
 - Standardised KSB motor with integrated frequency inverter
- Fluid properties:
 - Deaerated water
 - Fluid temperature: +20 °C.
 - Density: 1.0 kg/dm³
 - Kinematic viscosity: 1 mm²/s

n = 2900 rpm

Movitec; 2B; n = 2900 rpm

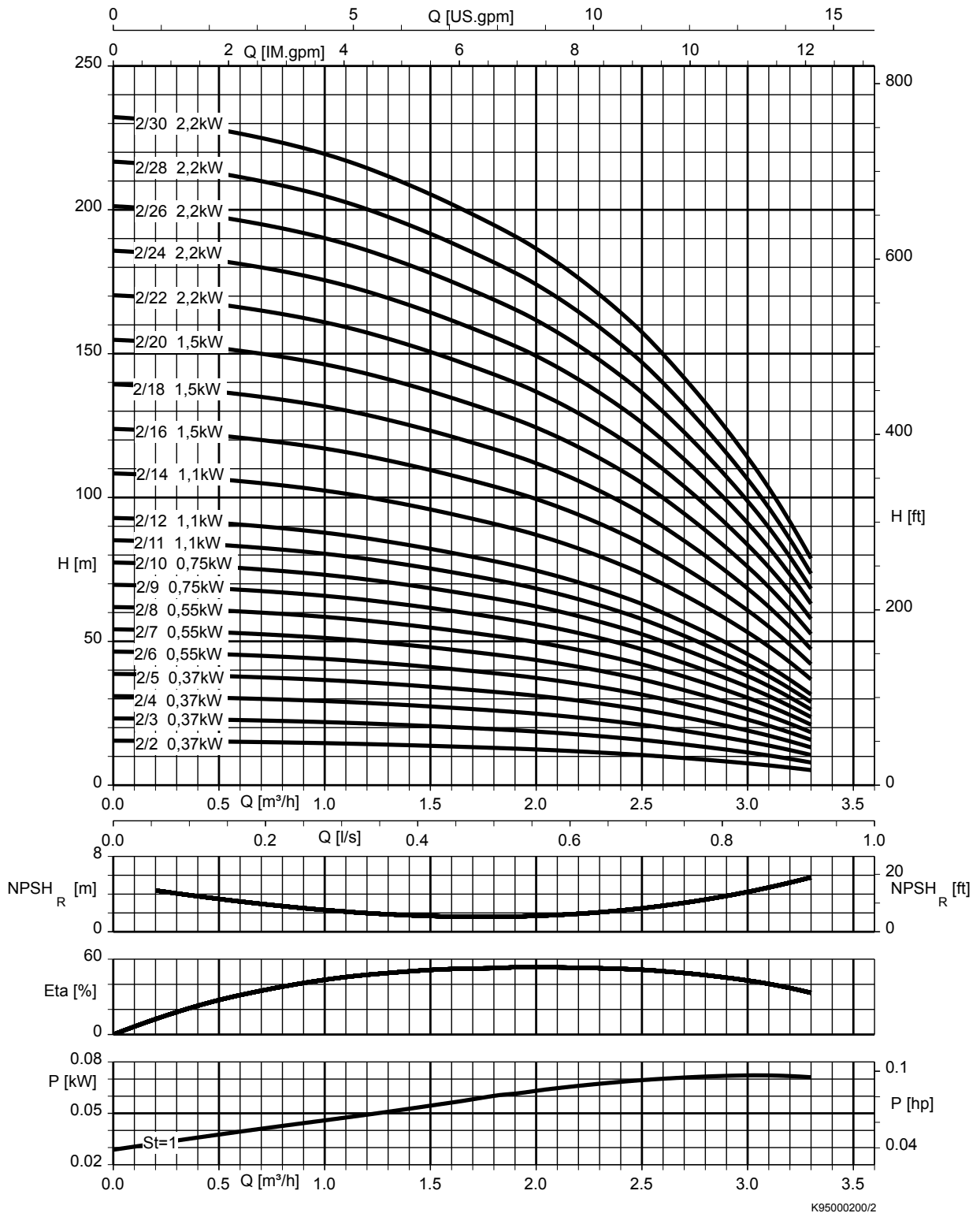

St =	Number of stages
The power input P is indicated per stage	

Movitec; 4B; n = 2900 rpm

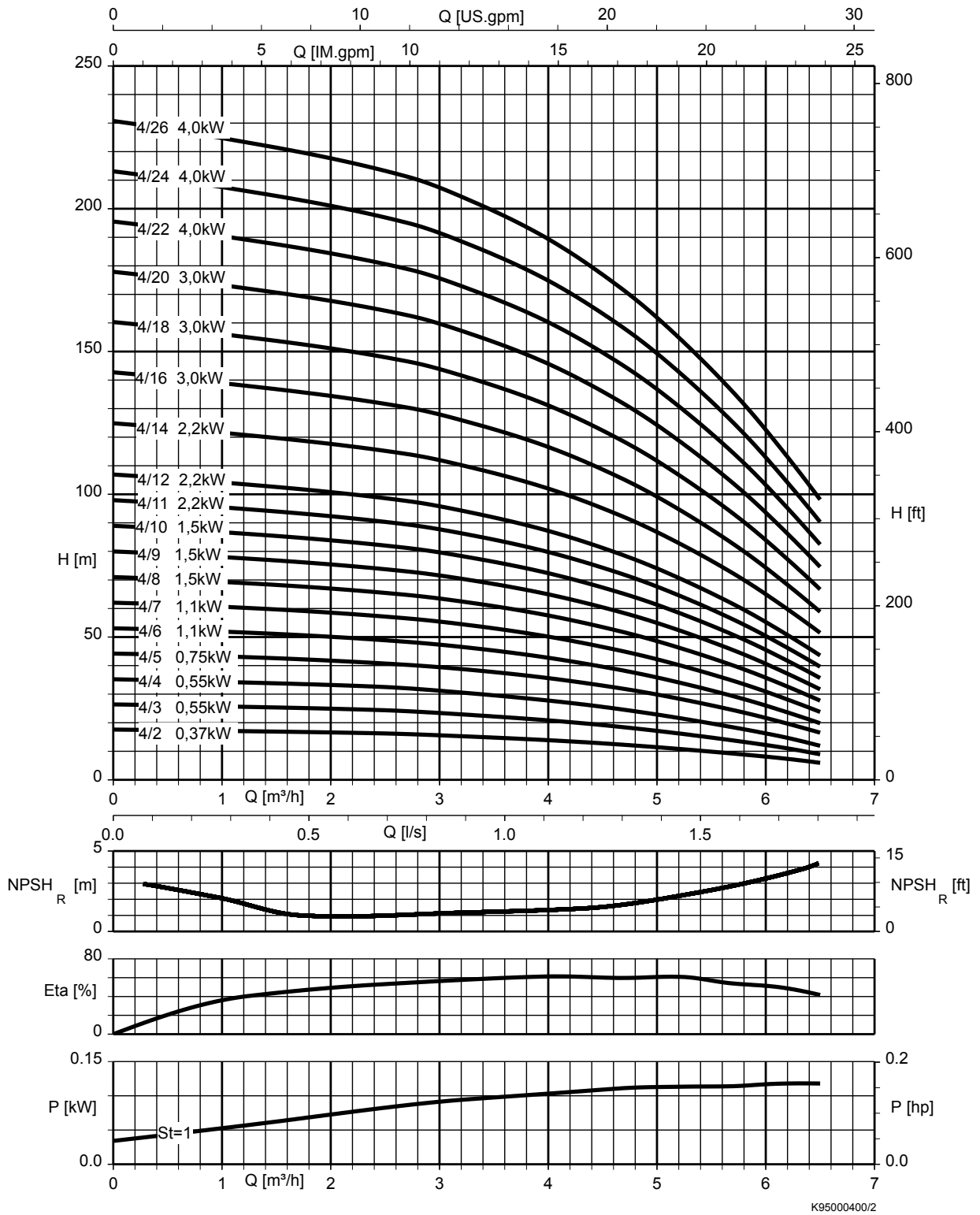

K95000400/2

St =	Number of stages
The power input P is indicated per stage	

Movitec; 6B; n = 2900 rpm

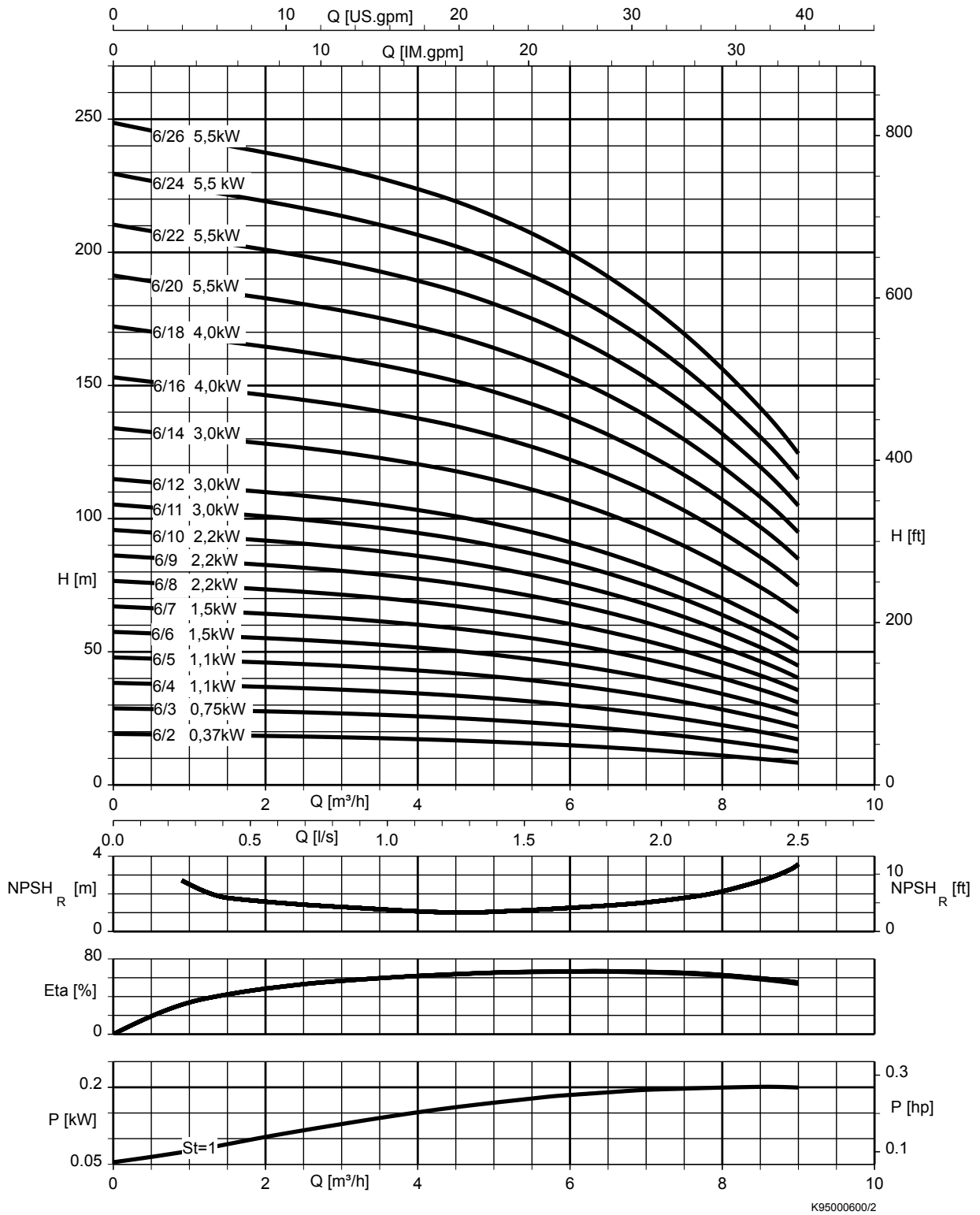

St =	Number of stages
The power input P is indicated per stage	

Movitec; 10B; n = 2900 rpm

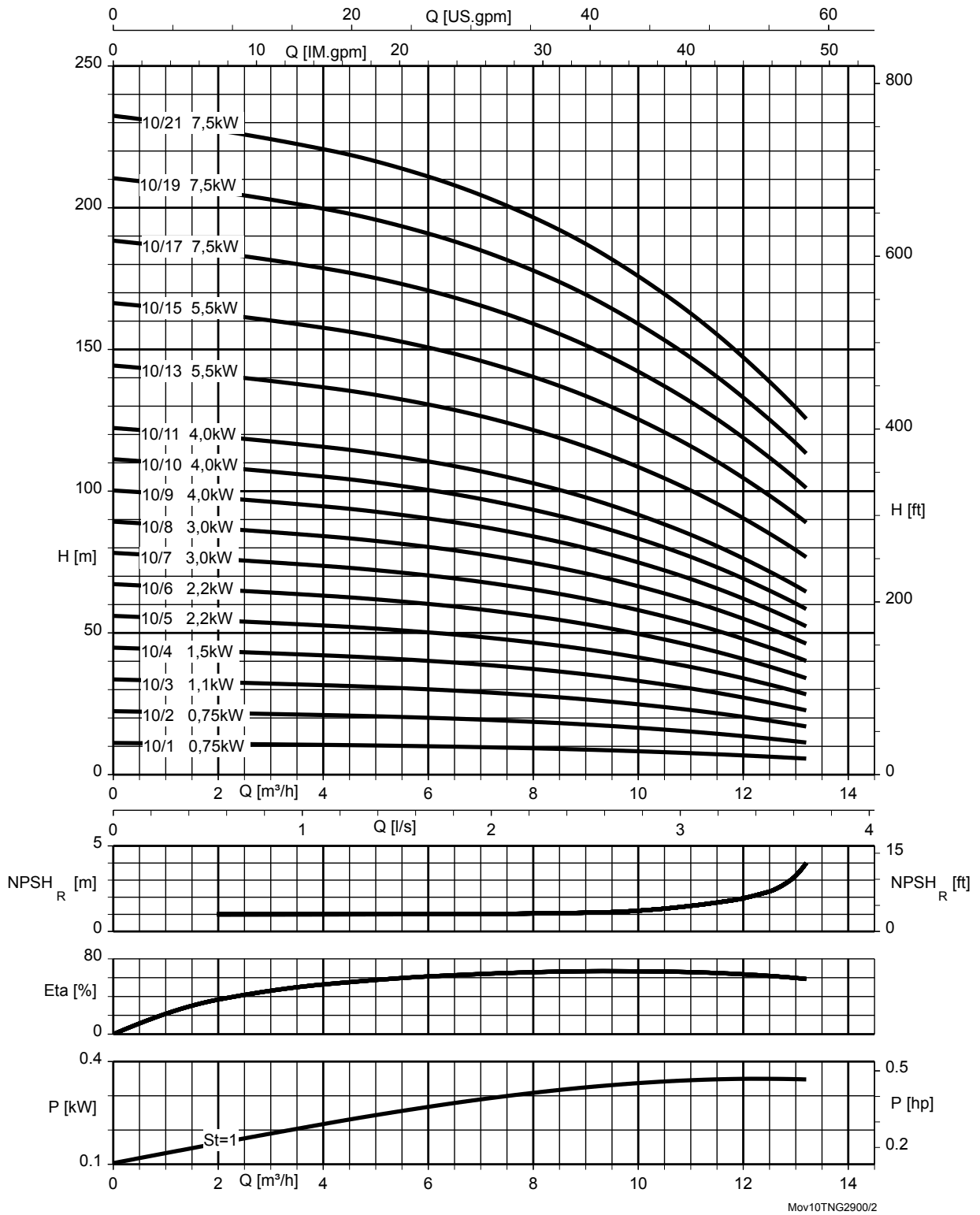

St =	Number of stages
The power input P is indicated per stage	

Movitec; 15B; n = 2900 rpm

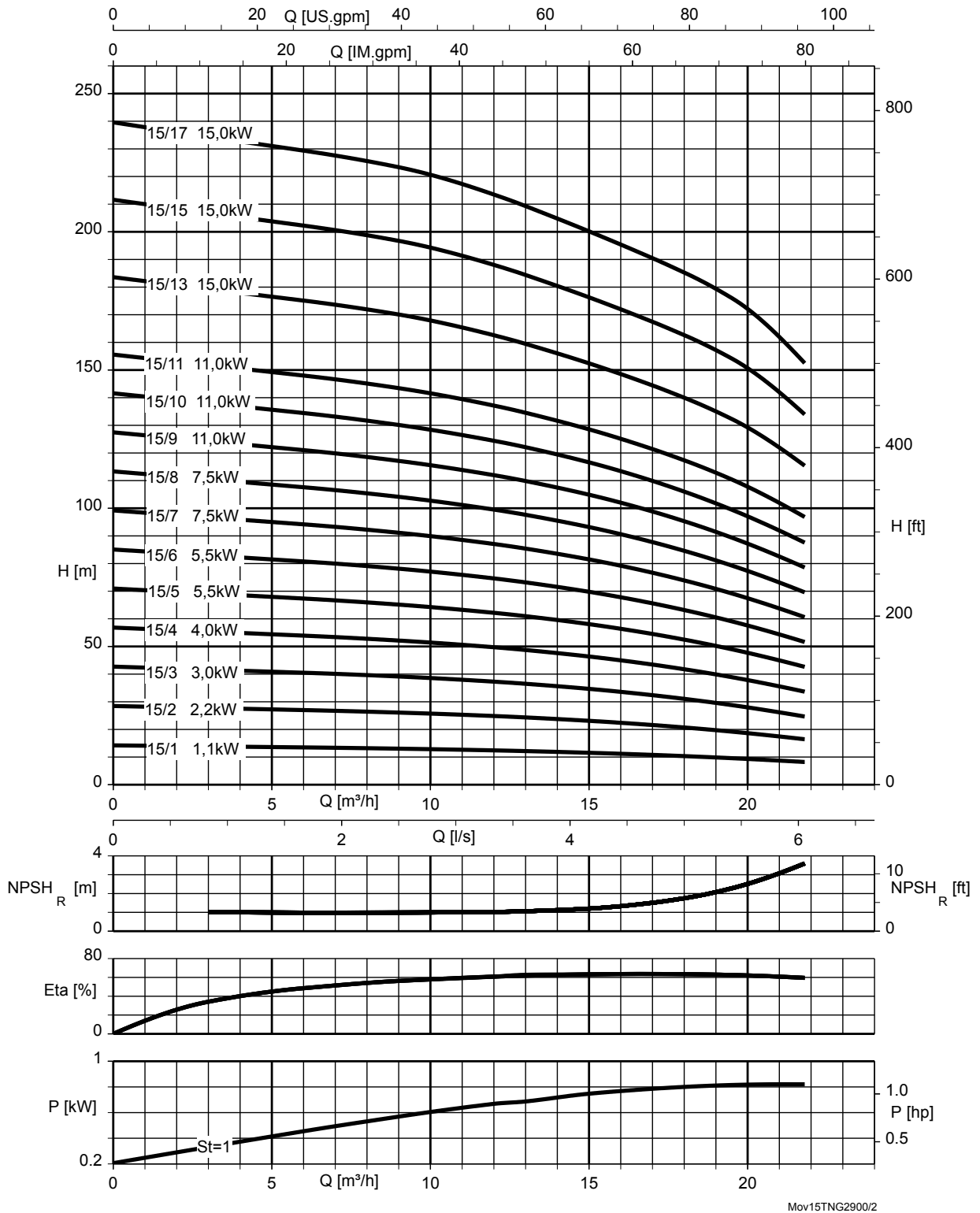

St =	Number of stages
The power input P is indicated per stage	

Movitec; 25B, n = 2900 rpm

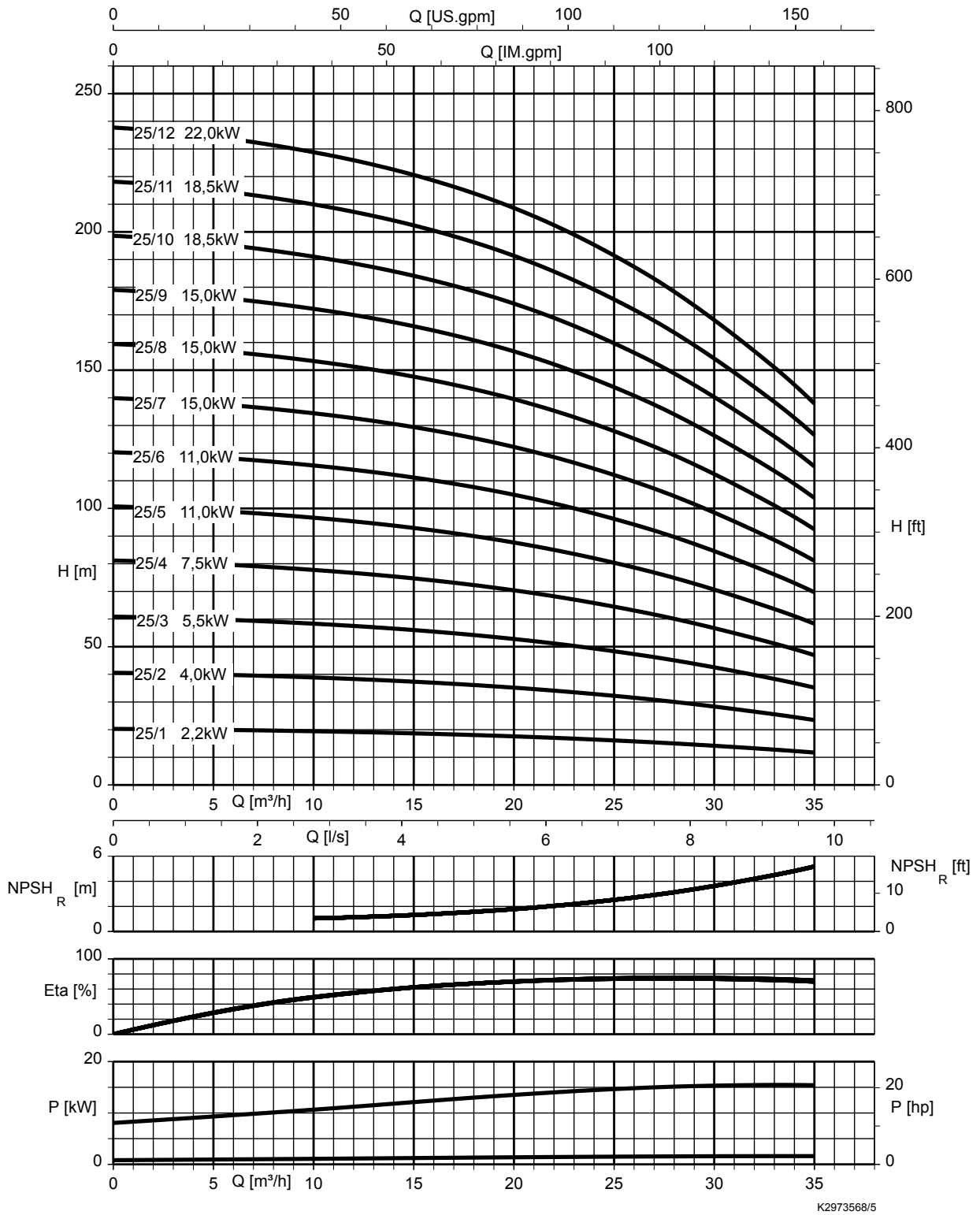

St =	Number of stages
The power input P is indicated per stage	

Movitec; 40B; n = 2900 rpm

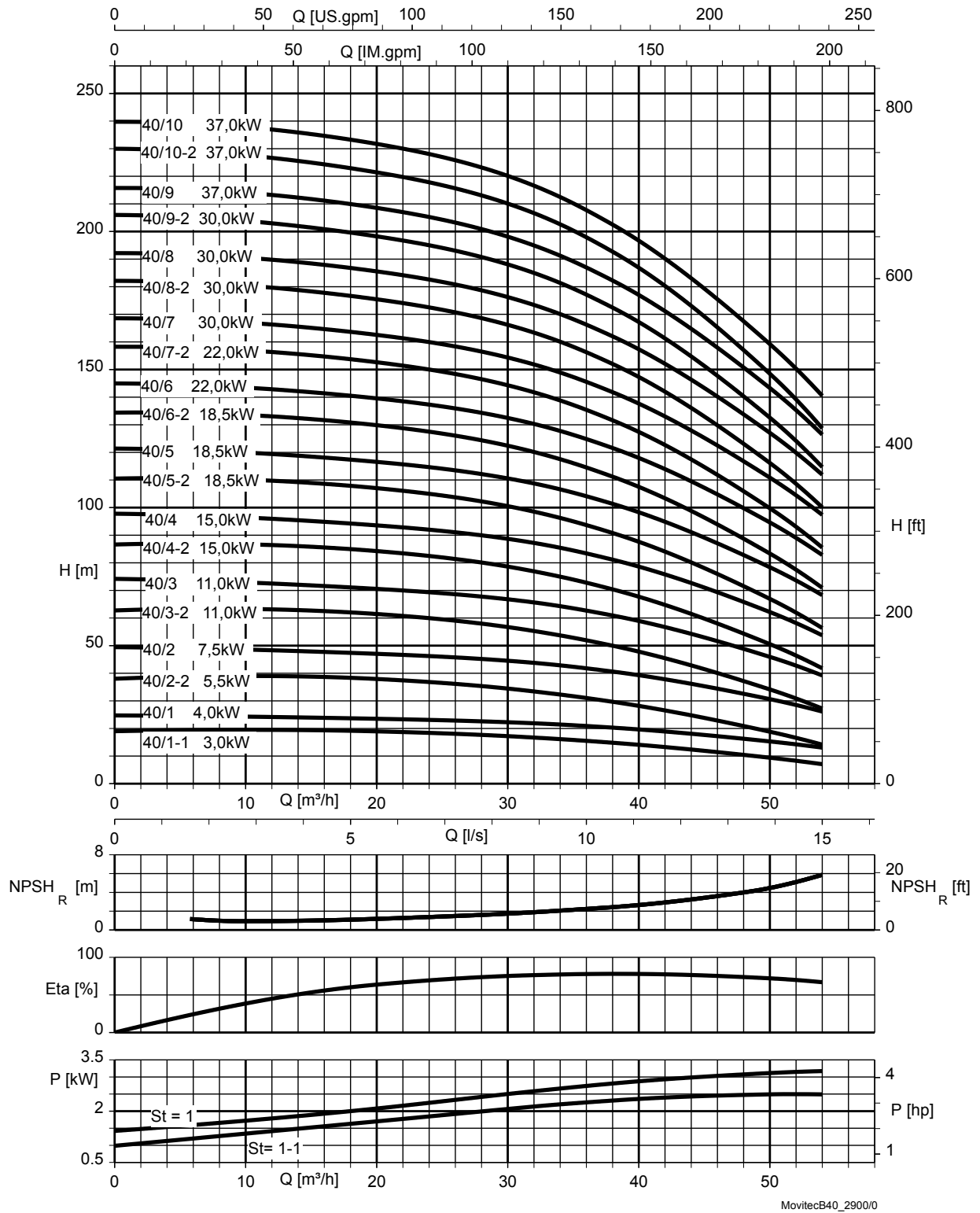

St =	Number of stages
The power input P is indicated per stage	

Movitec; 60B; n = 2900 rpm

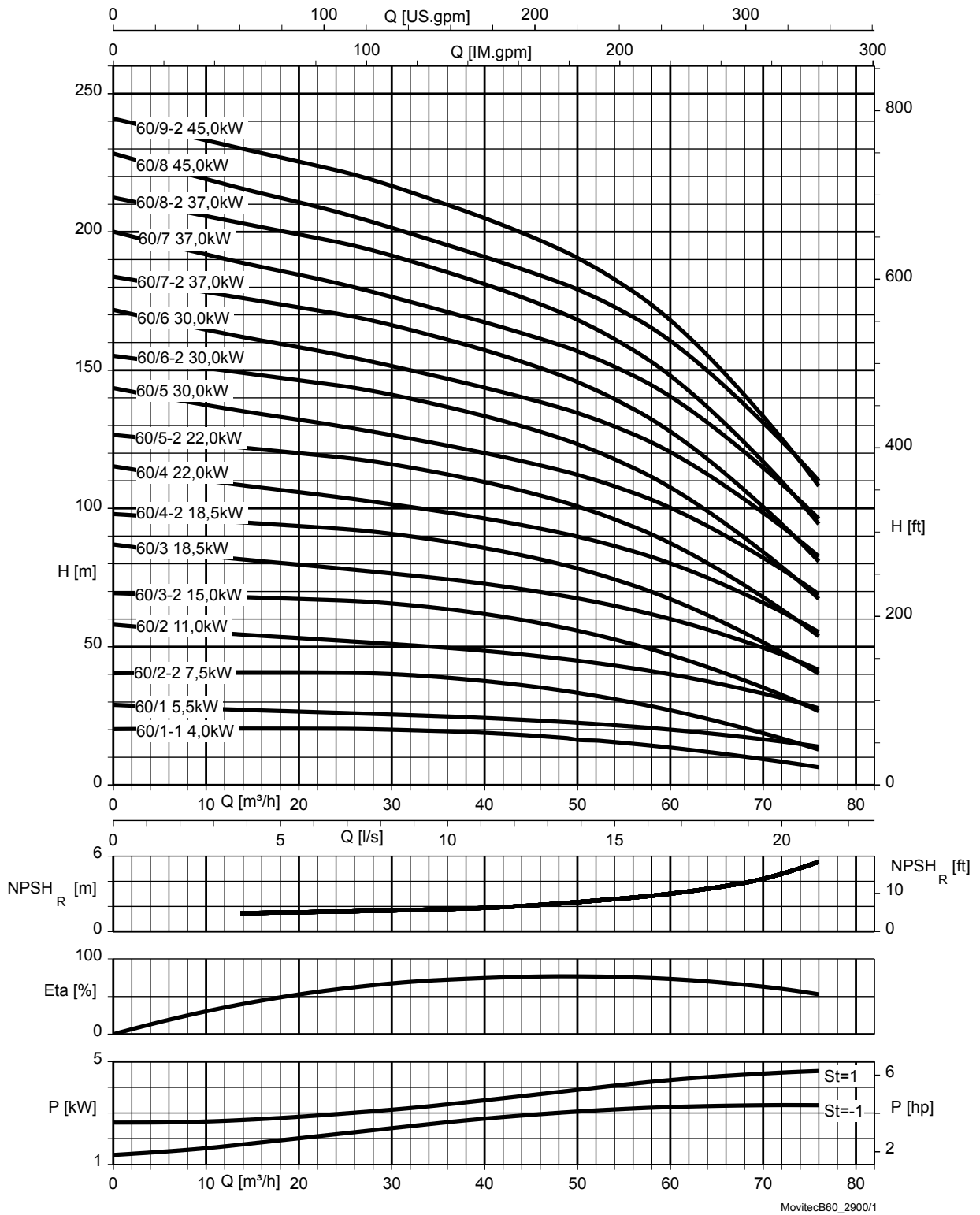

St =	Number of stages
The power input P is indicated per stage	

Movitec; 90B; n = 2900 rpm

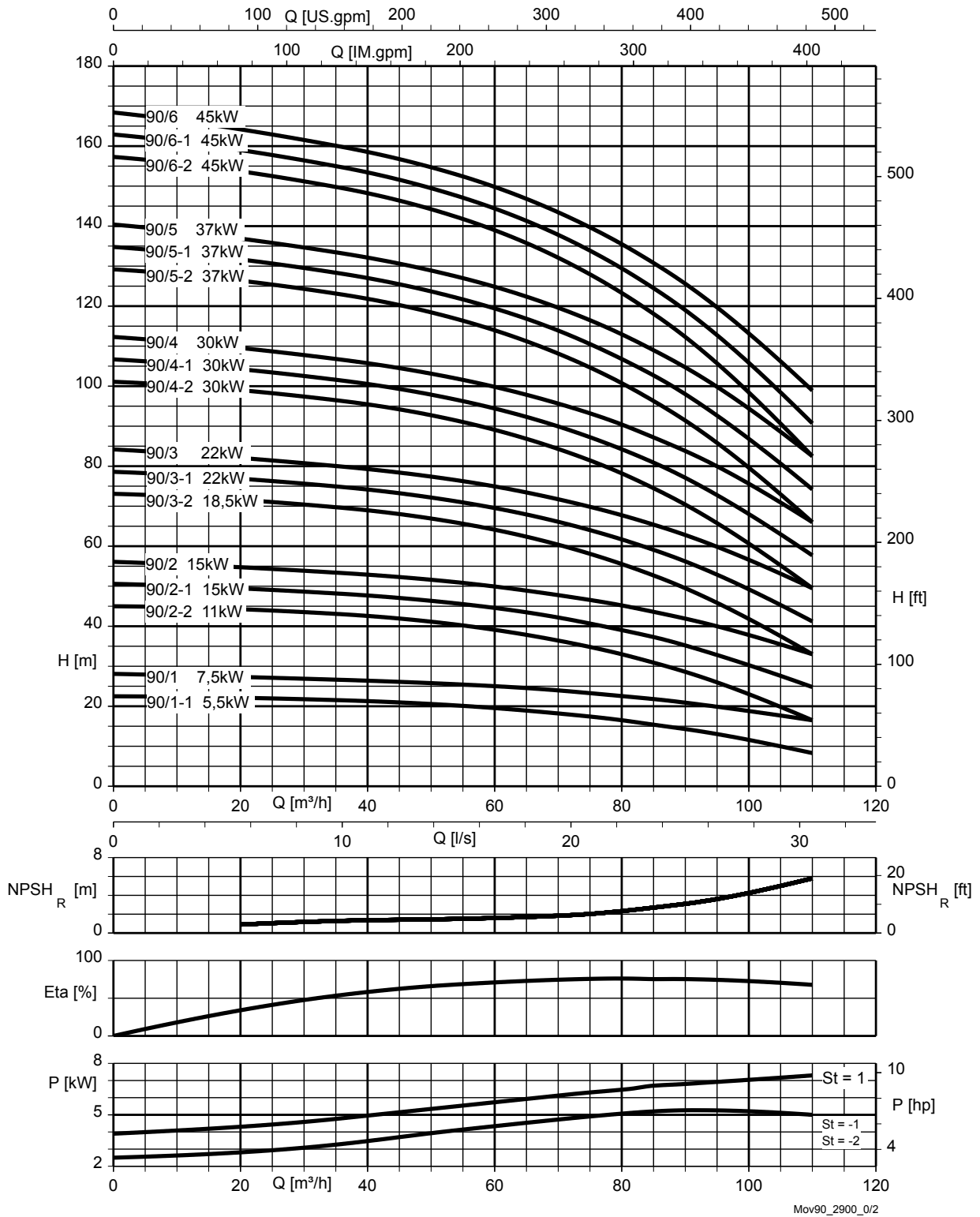

Mov90_2900_0/2

St =	Number of stages
The power input P is indicated per stage	

Movitec; LHS 6; n = 2900 rpm

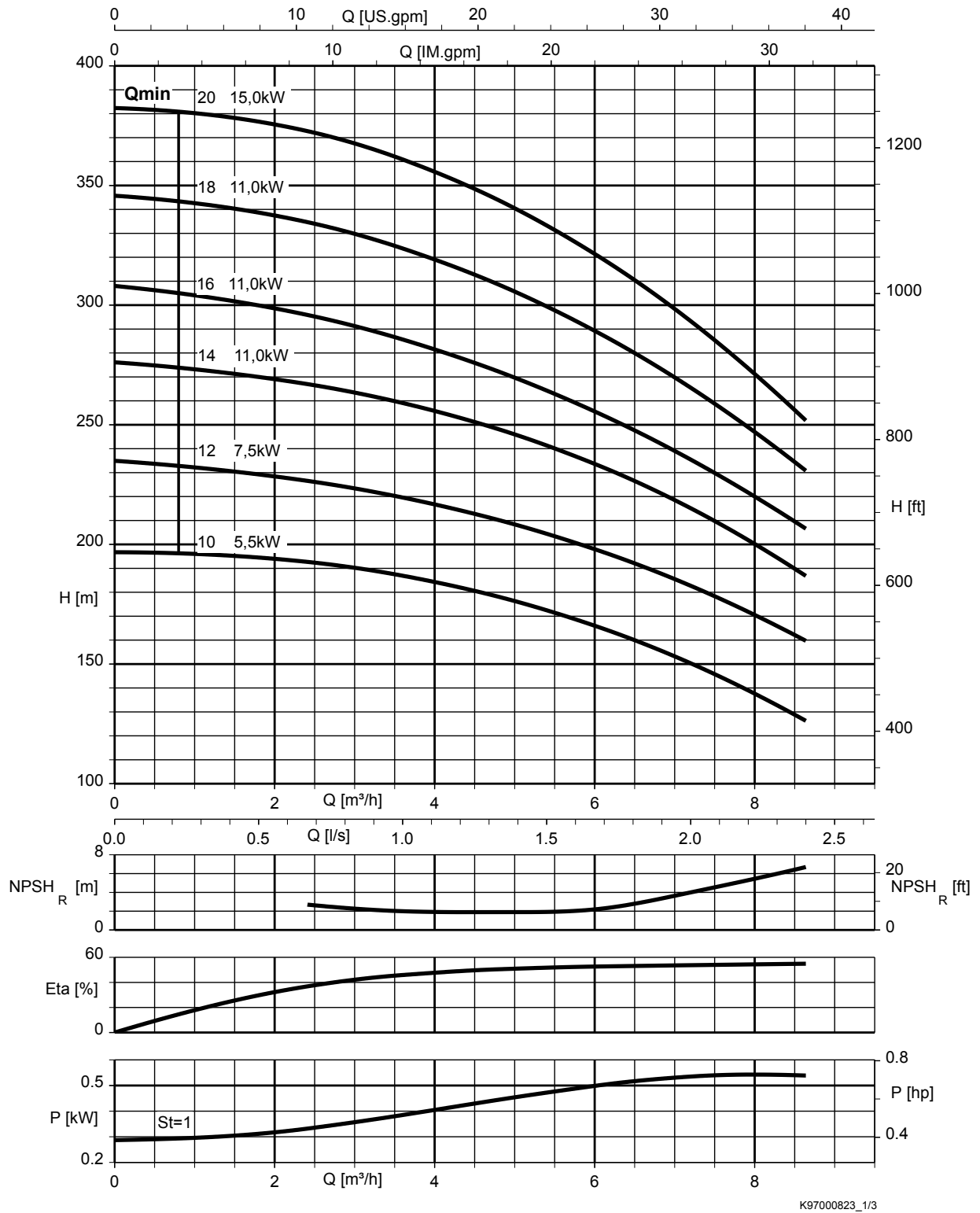

St =	Number of stages
The power input P is indicated per stage	

*) $Q_{min} \leq 40 \text{ }^\circ\text{C}$

n = 1450 rpm

Movitec; 10B; n = 1450 rpm

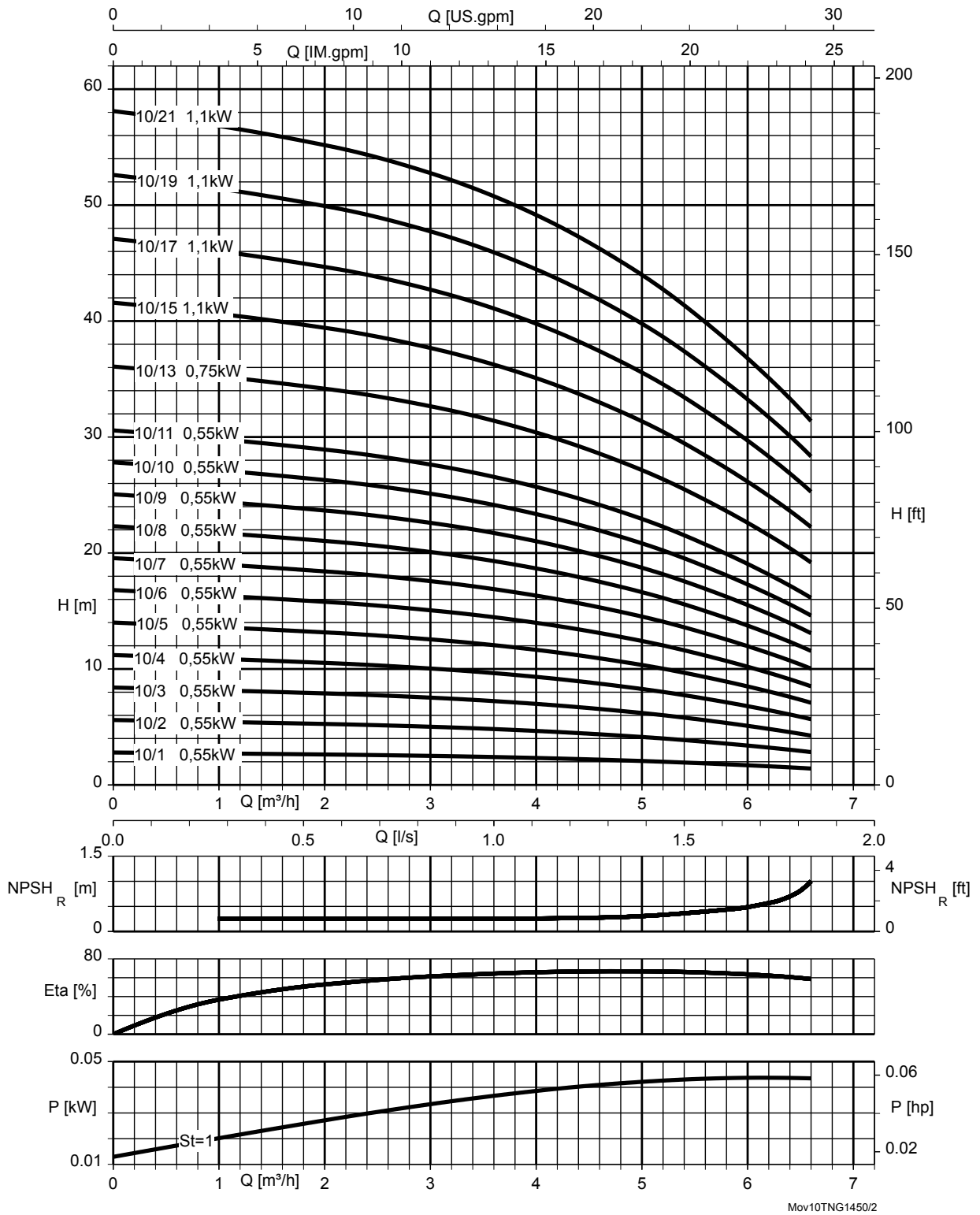

St =	Number of stages
The power input P is indicated per stage	

Movitec; 15B; n = 1450 rpm

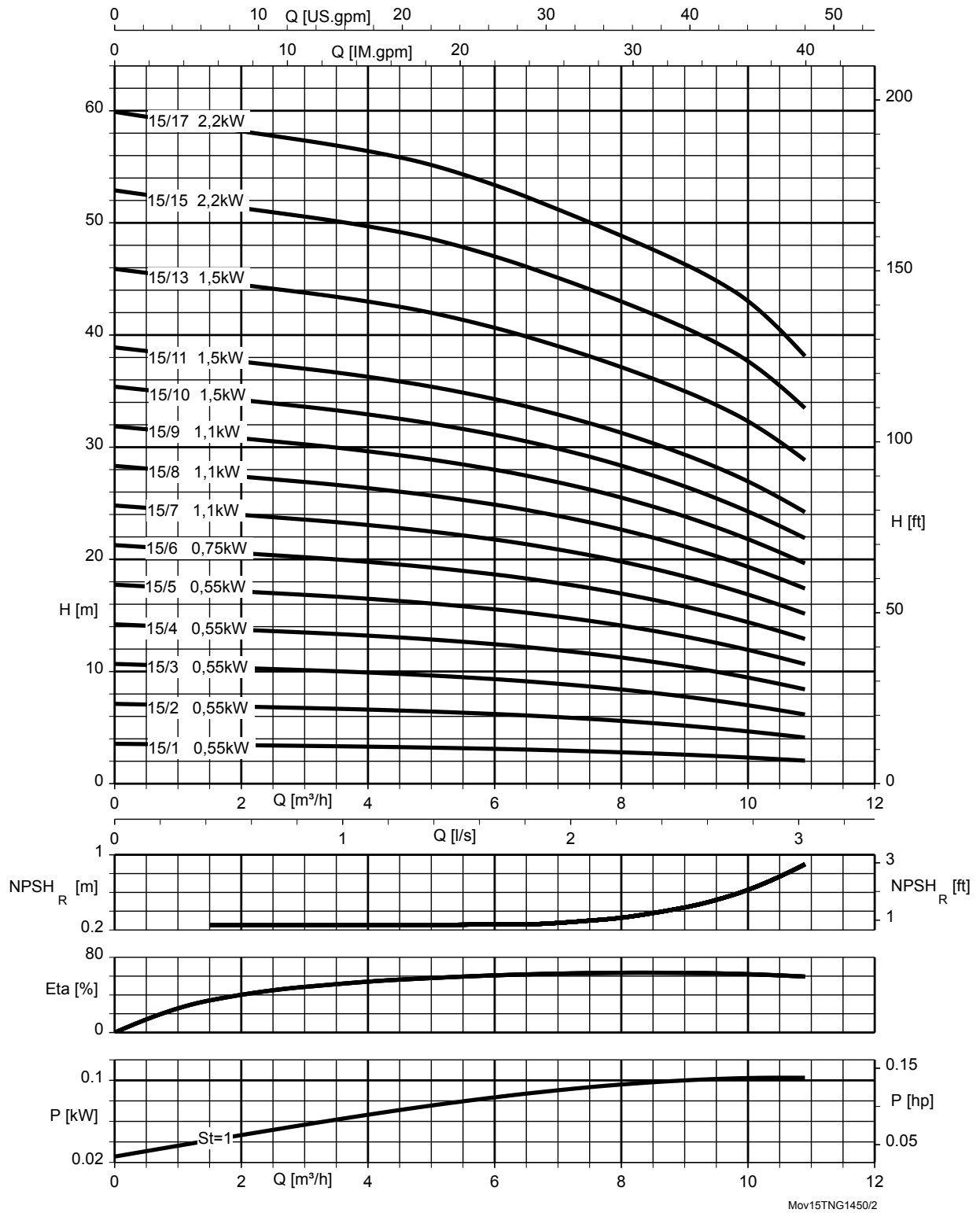

St =	Number of stages
The power input P is indicated per stage	

Movitec; 25B, n = 1450 rpm

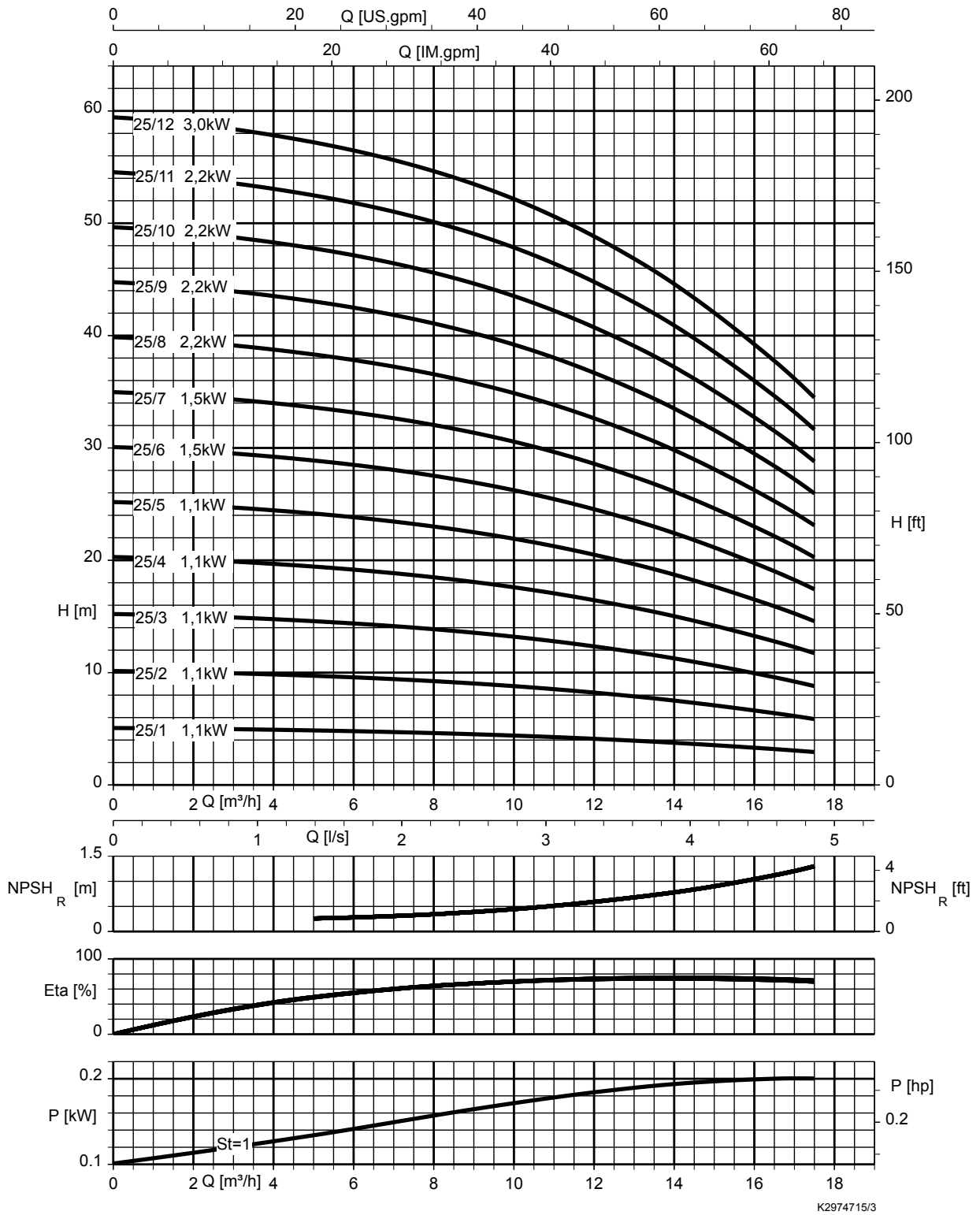

K2974715/3

St =	Number of stages
The power input P is indicated per stage	

Movitec; 40B; n = 1450 rpm

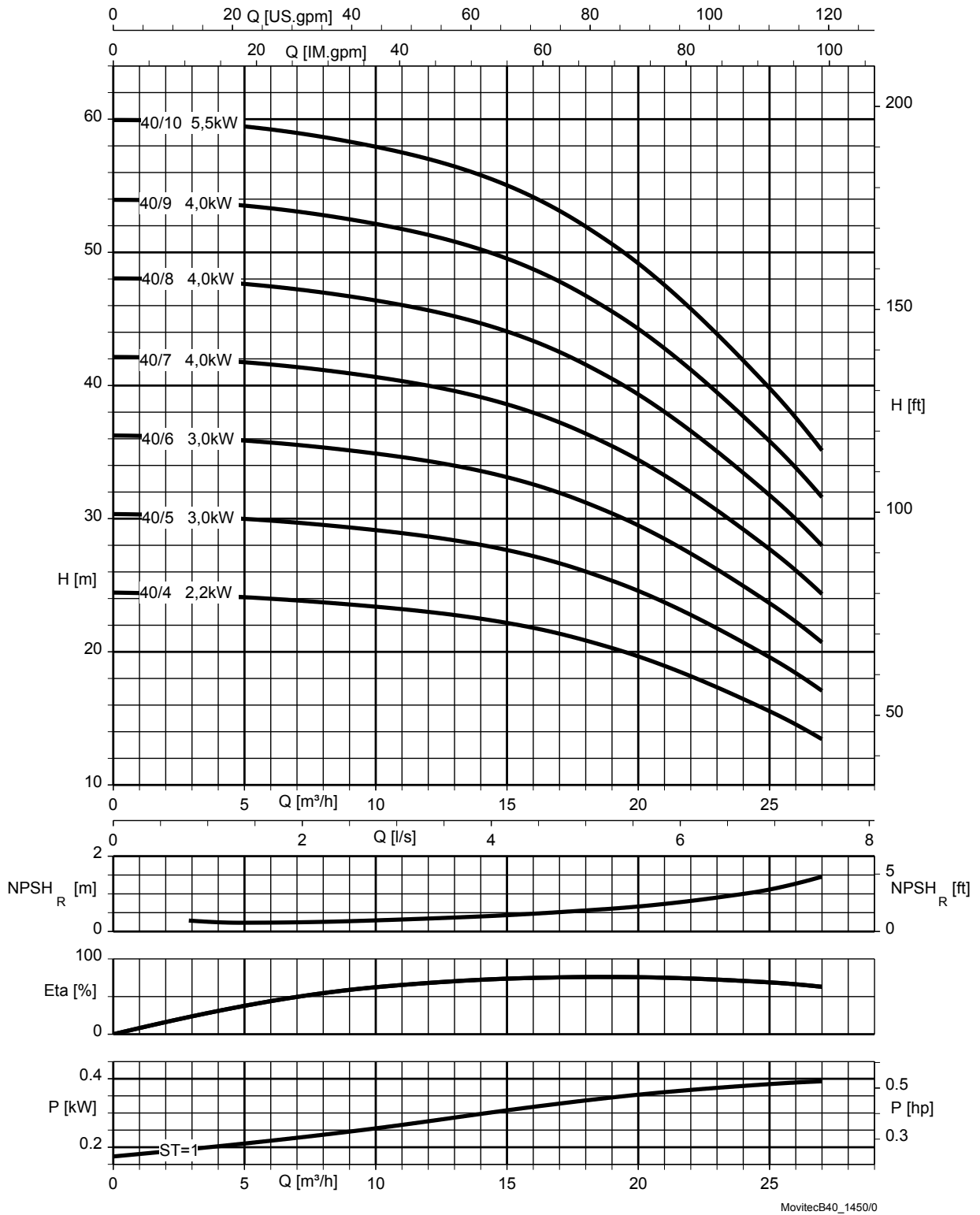

St =	Number of stages
The power input P is indicated per stage	

Movitec; 60B; n = 1450 rpm

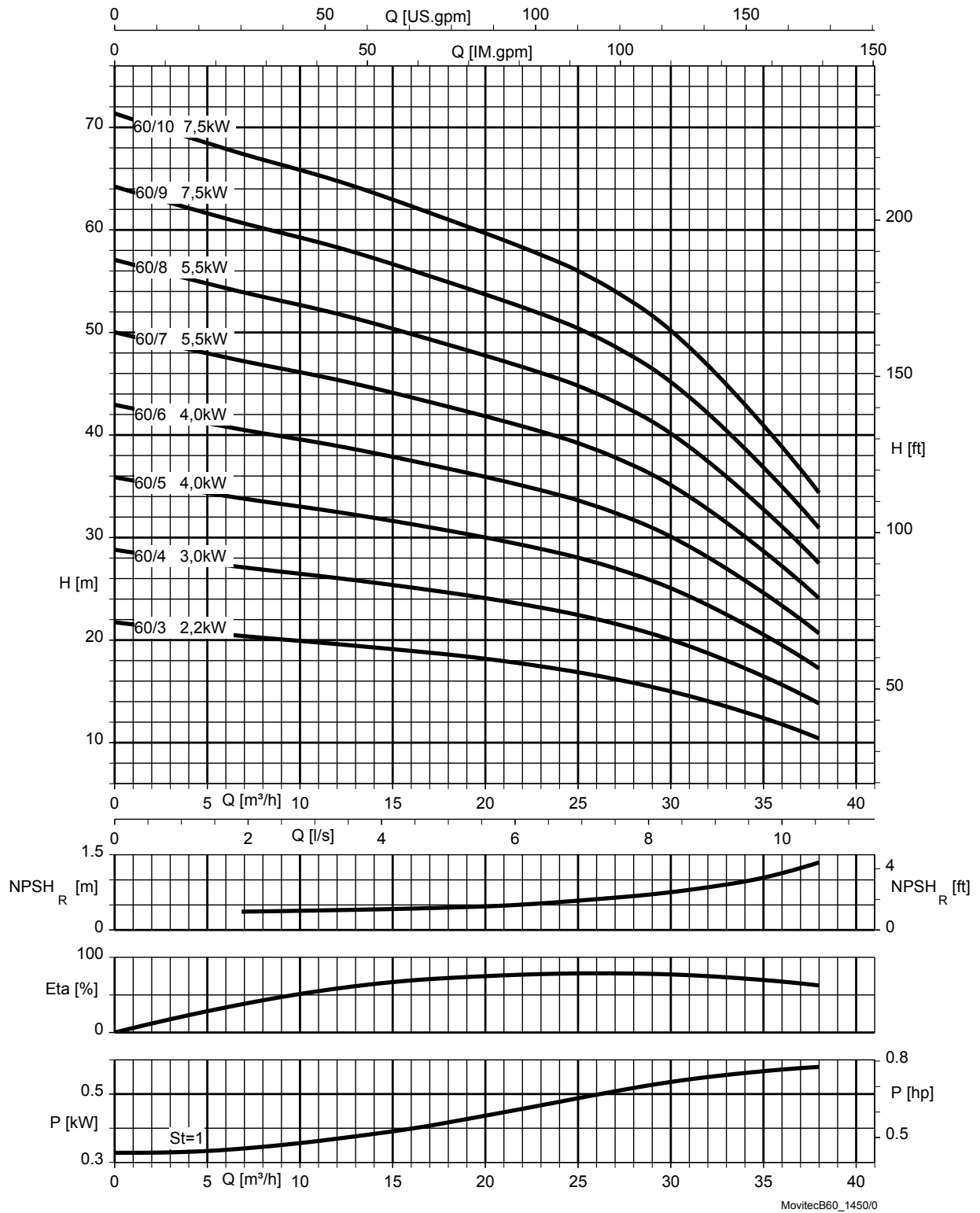

St =	Number of stages
The power input P is indicated per stage	

Movitec; 90B; n = 1450 rpm

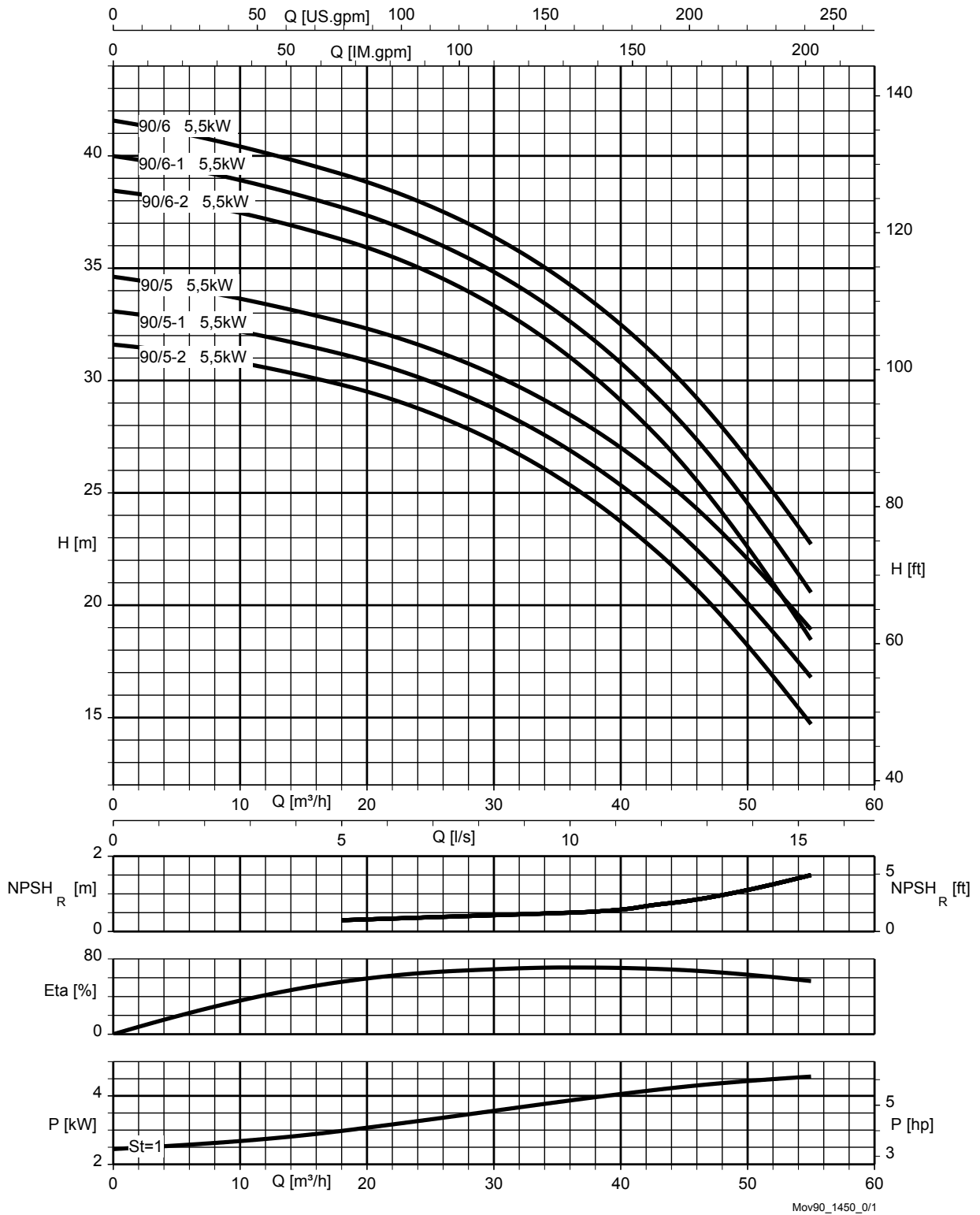

St =	Number of stages
The power input P is indicated per stage	

Dimensions

Movitec, 2B, n = 2900 rpm

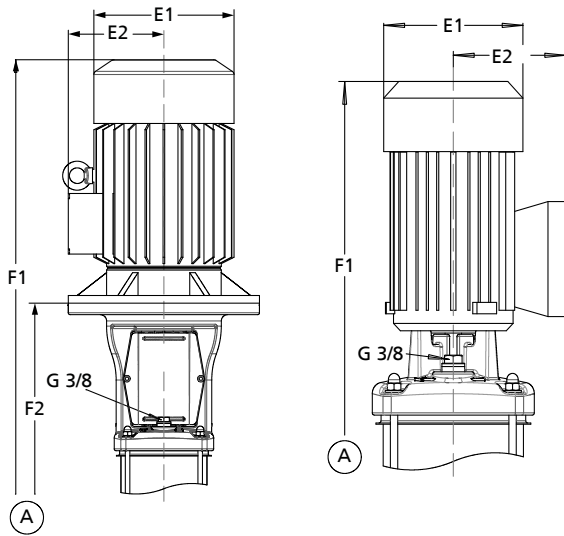

Movitec VVS, VV/VSV, VT/VST, VF/VSF, VCF

Movitec VME

Dimensions

Number of stages	E1	E2	Movitec				
			VVS; VV/VSV; VT/VST		VF/VSF; VCF		VME
			F1	F2	F1	F2	F1
[mm]							
2	138	109	472	259	497	284	420
3	138	109	493	280	518	305	441
4	138	109	515	302	540	327	463
5	138	109	536	323	561	348	484
6	138	109	558	345	583	370	506
7	138	109	579	366	604	391	-
8	138	109	601	388	626	413	-
9	160	150	676	419	701	444	-
10	160	150	698	441	723	466	-
11	160	150	719	462	744	487	-
12	160	150	741	484	766	509	-
14	160	150	784	527	809	552	-
16	185	160	833	580	858	605	-
18	185	160	876	623	901	648	-
20	185	160	919	666	944	691	-
22	185	160	-	-	1016	734	-
24	185	160	-	-	1059	777	-
26	185	160	-	-	1102	820	-
28	185	160	-	-	1145	863	-
30	185	160	-	-	1188	906	-

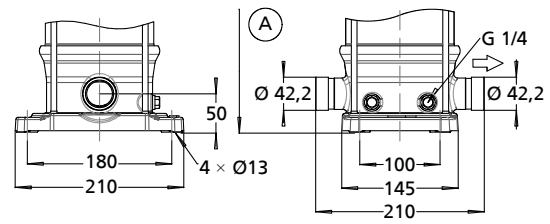

Movitec VV/VSV

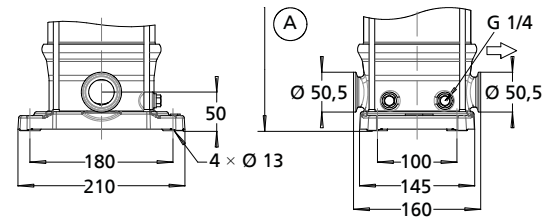

Movitec VT/VST

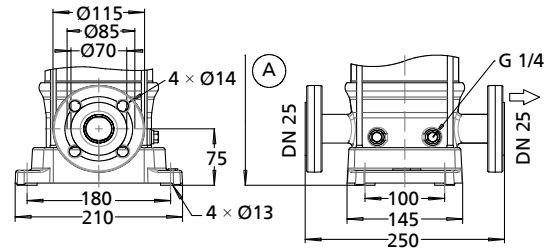

Movitec VF/VSF

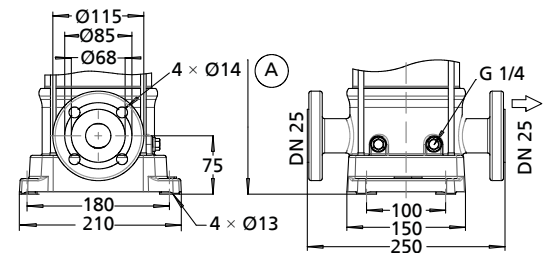

Movitec VCF

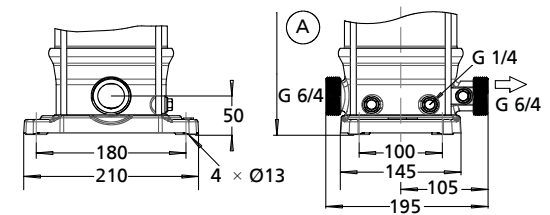

Movitec VME

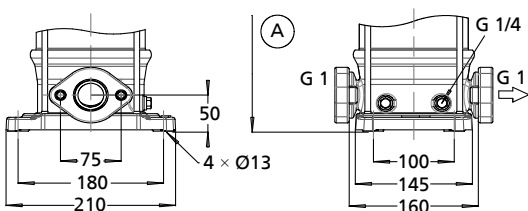

Movitec VVS

Movitec, 4B, n = 2900 rpm

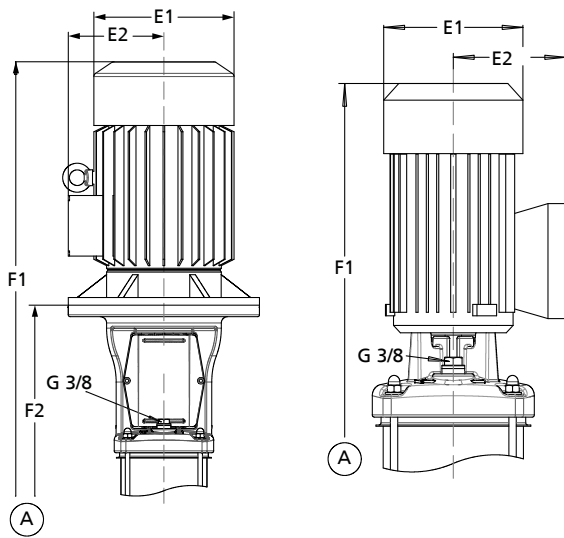

Movitec V/S, VV/VSV, VT/VST, VF/VSF, VCF

Movitec VME

Dimensions

Number of stages	E1	E2	Movitec				
			V/S; VV/VSV; VT/VST		VF/VSF; VCF		VME
			F1	F2	F1	F2	F1
[mm]							
2	138	109	472	259	497	284	420
3	138	109	493	280	518	305	441
4	138	109	515	302	540	327	463
5	160	150	590	333	615	358	528
6	160	150	612	355	637	380	556
7	160	150	633	376	658	401	-
8	185	160	661	408	686	433	-
9	185	160	682	429	707	454	-
10	185	160	704	451	729	476	-
11	185	160	754	472	779	497	-
12	185	160	776	494	801	519	-
14	185	160	819	537	844	562	-
16	205	175	904	590	929	615	-
18	205	175	-	-	972	658	-
20	205	175	-	-	1015	701	-
22	220	190	-	-	1067	744	-
24	220	190	-	-	1110	787	-
26	220	190	-	-	1153	830	-

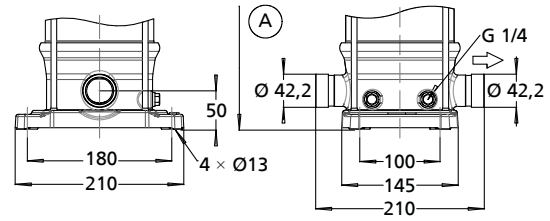

Movitec VV/VSV

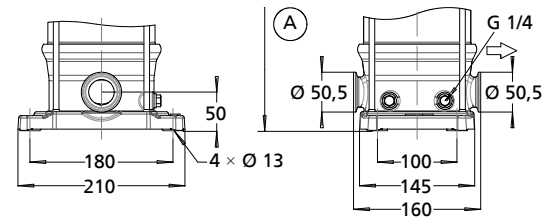

Movitec VT/VST

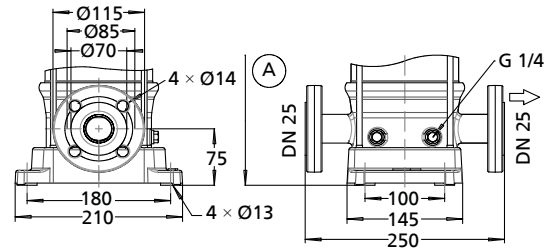

Movitec VF/VSF

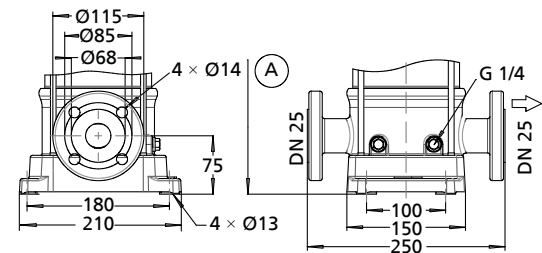

Movitec VCF

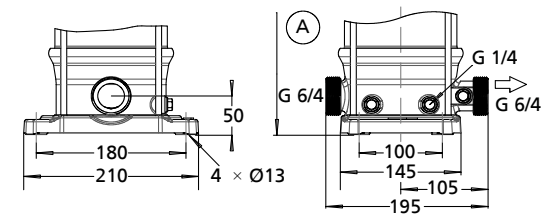

Movitec VME

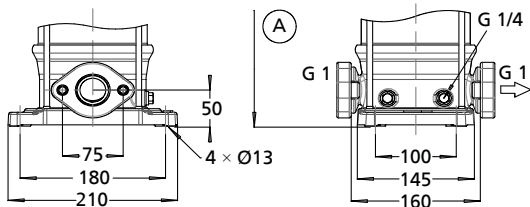

Movitec V/S

Movitec, 6B, n = 2900 rpm

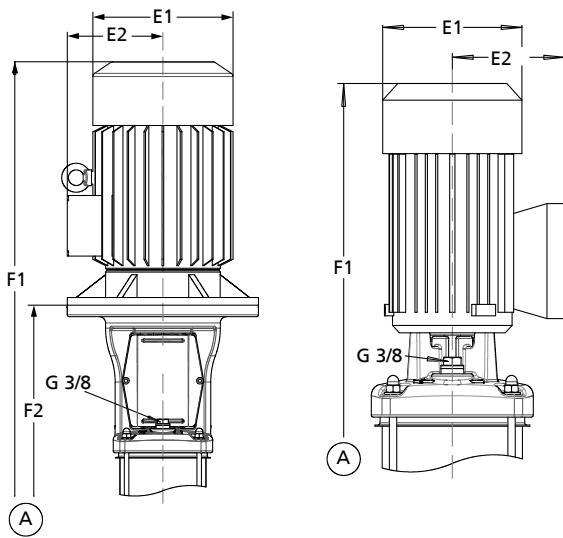

Movitec V/S, VV/VSF, VT/VST, VF/VSF, VCF

Movitec VME

Dimensions

Number of stages	E1	E2	Movitec				
			V/S; VV/VSV; VT/VST		VF/VSF; VCF		VME
			F1	F2	F1	F2	F1
[mm]							
2	138	109	479	266	504	291	427
3	160	150	558	301	563	326	496
4	160	150	583	326	608	351	521
5	160	150	608	351	633	376	546
6	185	160	639	386	664	411	-
7	185	160	664	411	689	436	-
8	185	160	718	436	743	461	-
9	185	160	743	461	768	486	-
10	185	160	768	486	793	511	-
11	205	175	835	521	860	546	-
12	205	175	860	546	885	571	-
14	205	175	910	596	935	621	-
16	220	190	869	646	994	671	-
18	220	190	-	-	1044	721	-
20	260	220	-	-	1193	847	-
22	260	220	-	-	1243	897	-
24	260	220	-	-	1293	947	-
26	260	220	-	-	1343	997	-

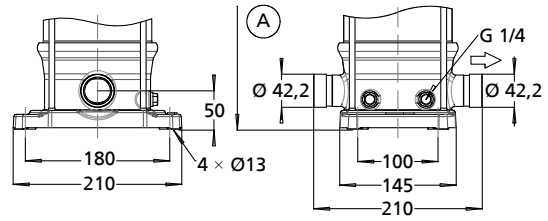

Movitec VV/VSV

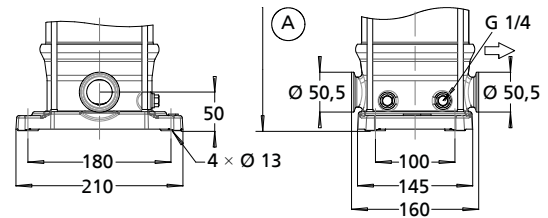

Movitec VT/VST

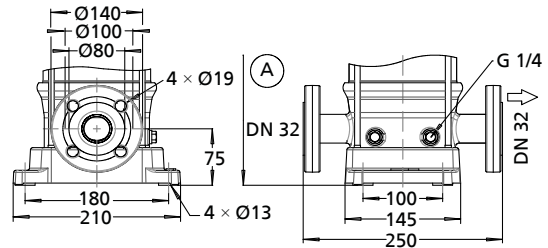

Movitec VF/VSF

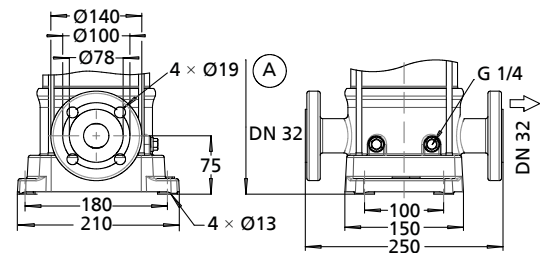

Movitec VCF

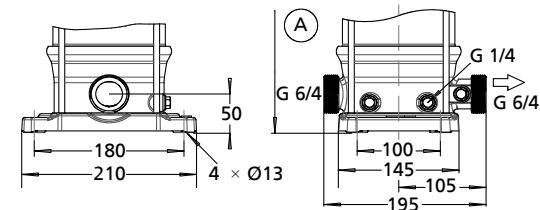

Movitec VME

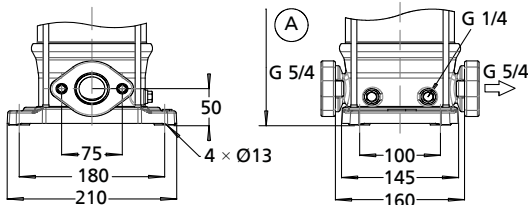

Movitec V/S

Movitec, 10B, n = 1450 rpm

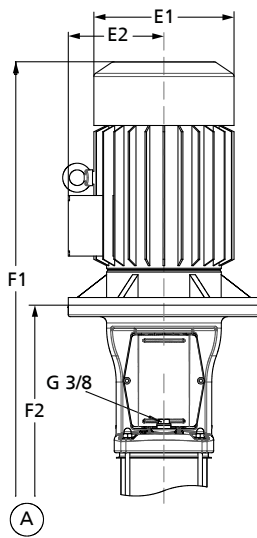

Movitec V/VS, VV/VSF, VT/VST, VF/VSF, VCF

Dimensions

Number of stages	E1	E2	Movitec			
			V/VS; VV/VSF; VT/VST		VF/VSF; VCF	
			F1	F2	F1	F2
[mm]						
1	138.5	110	592	346	592	346
2	138.5	110	592	346	592	346
3	138.5	110	618	372	618	372
4	138.5	110	645	399	645	399
5	138.5	110	671	425	671	425
6	138.5	110	698	452	698	452
7	138.5	110	724	478	724	478
8	138.5	110	750	505	750	505
9	138.5	110	777	531	777	531
10	138.5	110	804	558	804	558
11	138.5	110	830	584	830	584
13	159	155	912	672	912	672
15	159	155	970	700	970	700
17	159	155	1023	733	1023	753
19	159	155	1076	806	1076	806
21	159	155	1129	859	1129	859

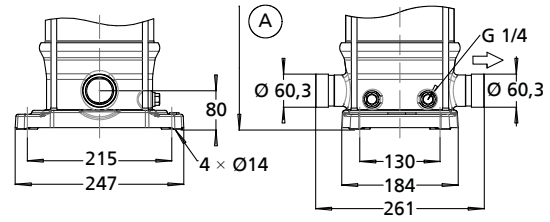

Movitec VV/VSV

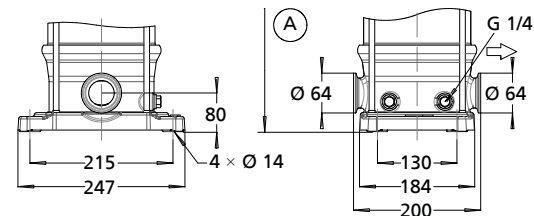

Movitec VT/VST

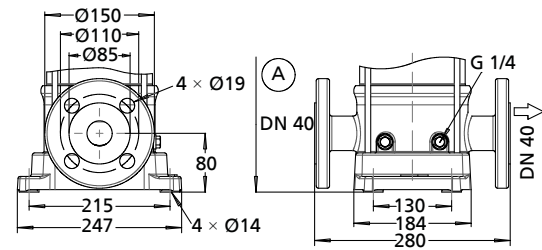

Movitec VF/VSF

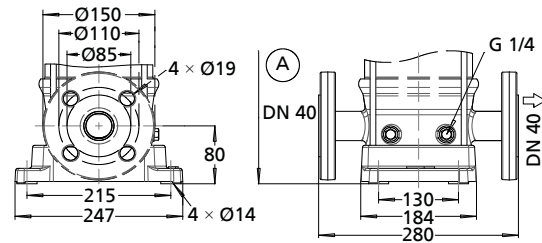

Movitec VCF

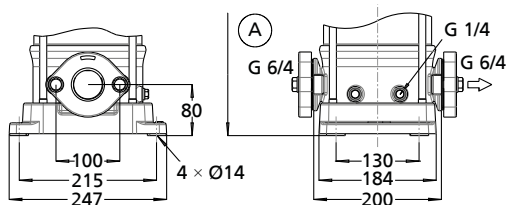

Movitec V/VS

Movitec, 10B, n = 2900 rpm

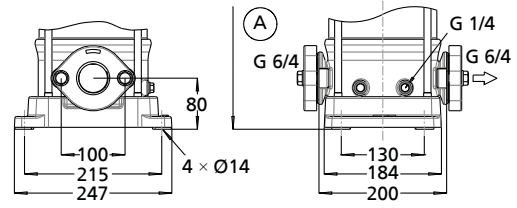
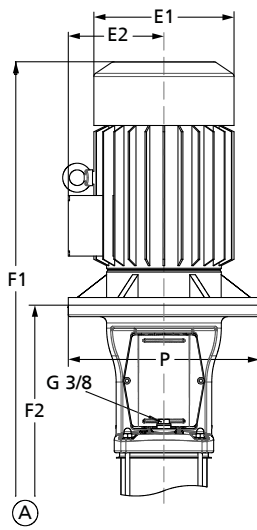

Movitec VVS

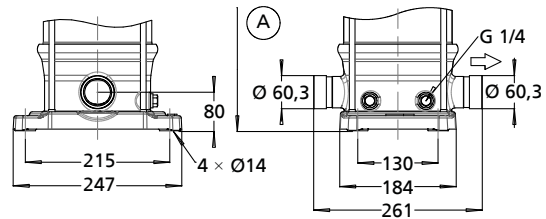

Movitec VV/SV

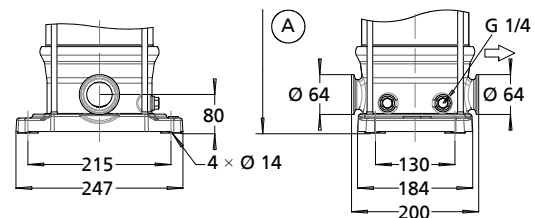

Movitec VVS, VV/SF, VT/VST,
VF/SF, VCF

Dimensions

Number of stages	E1	E2	p ²⁴⁾	Movitec			
				VVS; VV/SV; VF/SF; VCF VT/VST			
				F1	F2	F1	F2
[mm]							
1	160	150	-	621	346	621	346
2	160	150	-	621	346	621	346
3	160	150	-	647	372	647	372
4	185	160	-	679	409	679	409
5	185	160	-	720	435	720	435
6	185	160	-	747	462	747	462
7	205	175	-	828	498	828	498
8	205	175	-	855	525	855	525
9	205	175	-	891	551	891	551
10	205	175	-	918	578	918	578
11	205	175	-	944	604	944	604
13	260	220	300	1102	737	1102	737
15	260	220	300	1155	790	1155	790
17	260	220	300	1208	843	1208	843
19	260	220	300	1261	896	1261	896
21	260	220	300	1314	949	1314	949

Movitec VT/VST

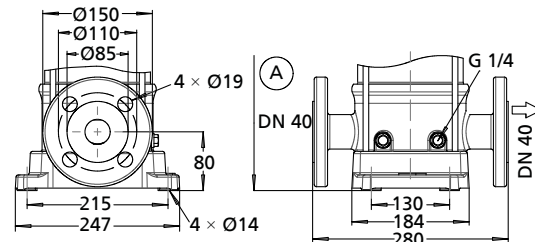

Movitec VF/SF

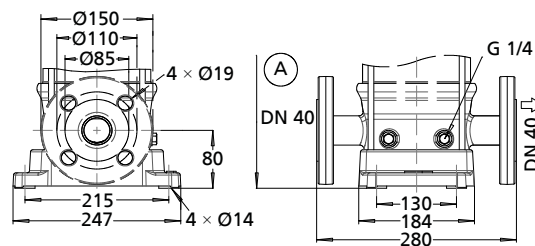

Movitec VCF

24) Only relevant for motors > 5.5 kW

Movitec, 15B, n = 1450 rpm

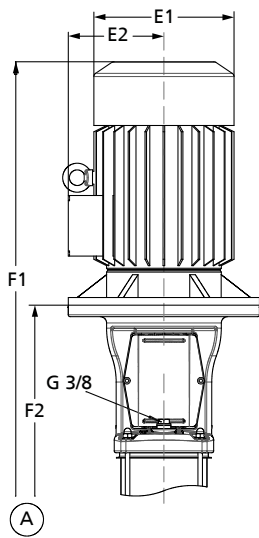

Movitec V/VS, VV/VSF, VT/VST, VF/VSF, VCF

Dimensions

Number of stages	E1	E2	Movitec			
			V/VS; VV/VSF; VT/VST		VF/VSF; VCF	
			F1	F2	F1	F2
[mm]						
1	138.5	110	592	346	602	356
2	138.5	110	592	346	602	356
3	138.5	110	618	372	628	382
4	138.5	110	645	399	655	409
5	138.5	110	671	425	681	435
6	159	155	727	452	737	462
7	159	155	758	488	768	498
8	159	155	785	515	795	525
9	159	155	811	541	821	551
10	176.5	160	853	568	863	578
11	176.5	160	879	594	889	604
13	176.5	160	932	647	942	657
15	176.5	160	1040	710	1050	720
17	176.5	160	1093	763	1103	773

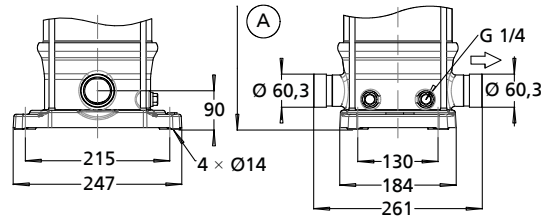

Movitec VV/VSF

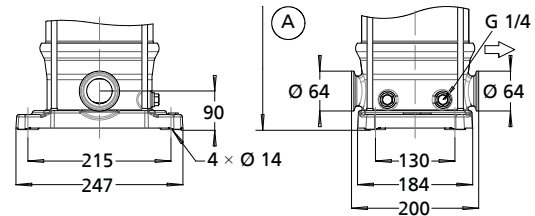

Movitec VT/VST

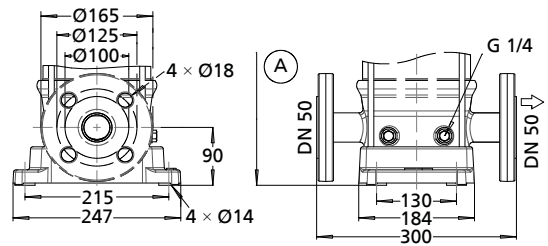

Movitec VF/VSF

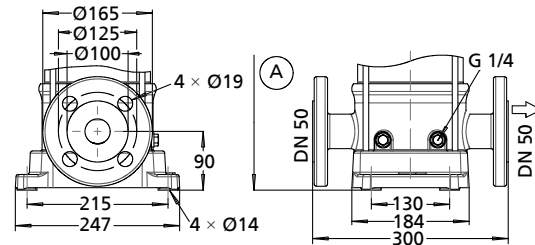

Movitec VCF

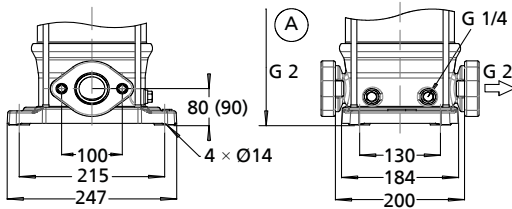

Movitec V/VS

Movitec, 15B, n = 2900 rpm

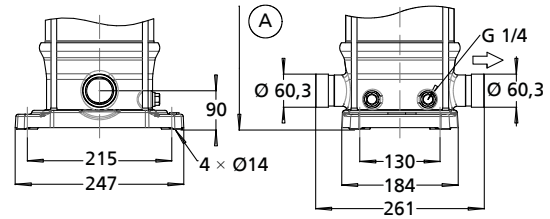
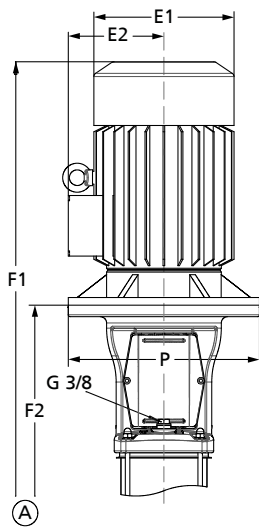

Movitec VV/VSV

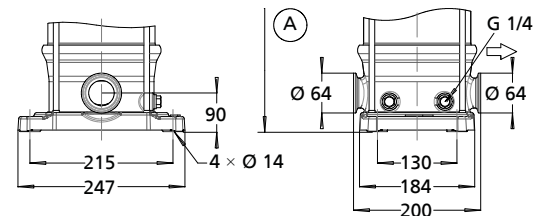

Movitec VT/VST

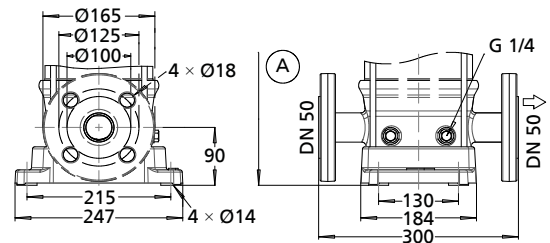

Movitec VF/VSF

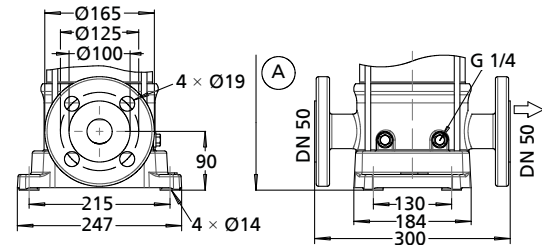

Movitec VCF

Movitec VVS, VVVSF, VT/VST, VF/VSF, VCF

Dimensions

Number of stages	E1	E2	p ²⁵⁾	Movitec			
				VVS; VVVSF; VT/VST; VF/VSF; VCF			
				F1	F2	F1	F2
[mm]							
1	160	150	-	621	346	631	356
2	185	160	-	641	356	651	366
3	205	175	-	722	392	732	402
4	205	175	-	759	419	769	429
5	260	220	300	890	525	900	535
6	260	220	300	916	551	926	561
7	260	220	300	943	578	953	588
8	260	220	300	969	604	979	614
9	315	265	350	1159	661	1169	671
10	315	265	350	1185	687	1195	697
11	315	265	350	1222	724	1222	724
13	315	265	350	1275	777	1275	777
15	315	265	350	1328	830	1328	830
17	315	265	350	1381	883	1381	883

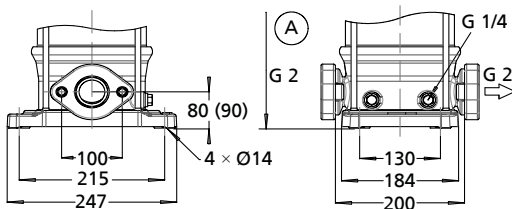

Movitec V/VS

25) Dimensions relevant for motors > 5.5 kW

Movitec, 25B, n = 1450 rpm

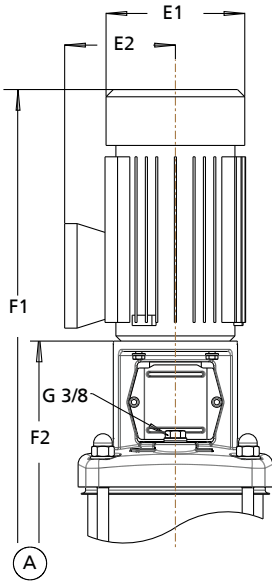

Movitec VF/VSF; VCF
Motor flange version with
tapped hole

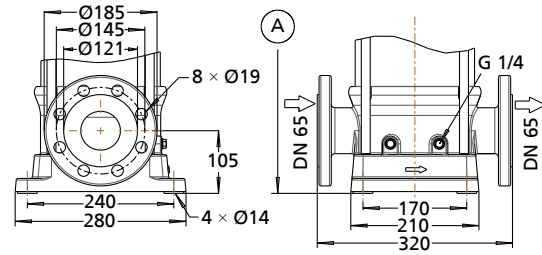

Movitec VCF

Dimensions

Number of stages	E1	E2	Movitec	
			VF/VSF; VCF	
			F1	F2
[mm]				
1	176	141	678	408
2	176	141	743	473
3	176	141	808	538
4	176	141	873	603
5	176	141	938	668
6	195	145	1018	733
7	195	145	1083	798
8	195	145	1198	868
9	195	145	1263	933
10	195	145	1328	998
11	195	145	1393	1063
12	195	145	1458	1128

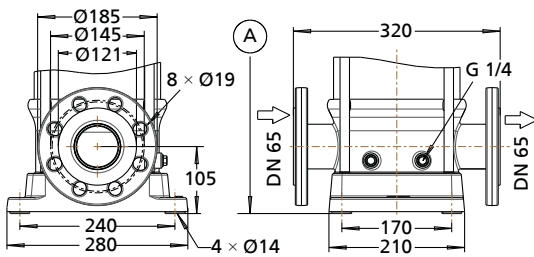

Movitec VF/VSF

Movitec, 25B, n = 2900 rpm

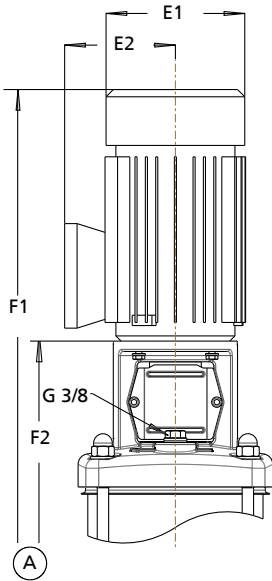

Movitec VF/VSF; VCF
Motor flange version with
tapped holes

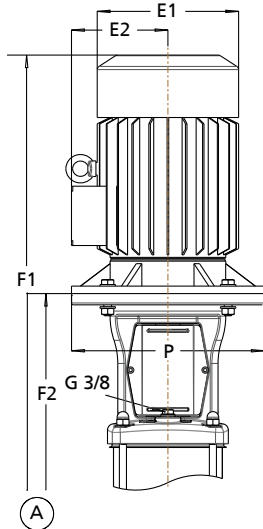

Movitec VF/VSF; VCF
Motor flange version with
throughholes

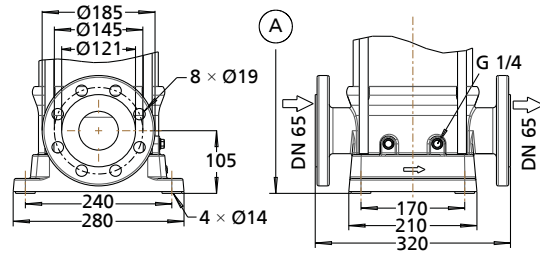

Movitec VCF

Dimensions

Motor flange version with tapped holes

Number of stages	E1	E2	P	Movitec	
				VF/VSF; VCF	
				F1	F2
[mm]					
1	185	160	-	693	408
2	220	190	-	818	478

Dimensions

Motor flange version with throughholes

Number of stages	E1	E2	P	Movitec	
				VF/VSF; VCF	
				F1	F2
[mm]					
3	260	220	300	999	634
4	260	220	300	1064	699
5	315	265	350	1292	794
6	315	265	350	1357	859
7	315	265	350	1422	924
8	315	265	350	1487	989
9	315	265	350	1552	1054
10	315	265	350	1699	1119
11	360	280	350	1764	1184
12	350	280	350	1829	1249

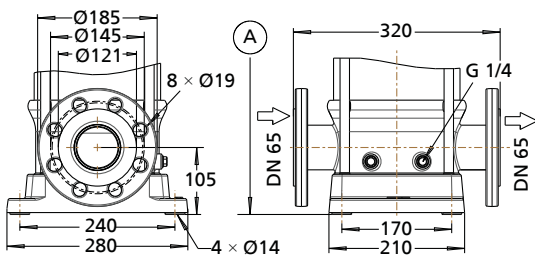

Movitec VF/VSF

Movitec, 40B, n = 1450 rpm

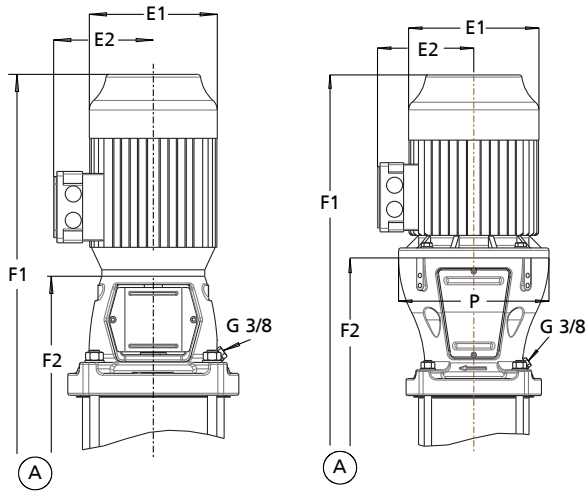

Movitec VF/VSF; VCF
Motor version V18

Movitec VF/VSF; VCF
Motor version V1

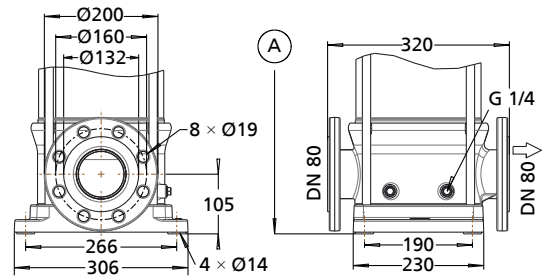

Movitec VF/VSF - interchangeable range

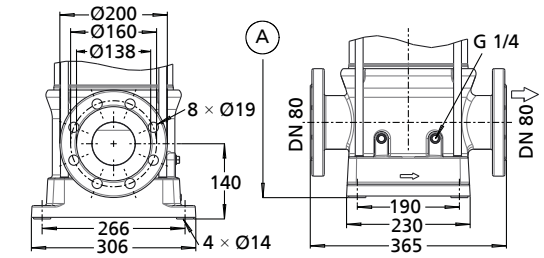

Movitec VCF

Dimensions
Motor version V18

Number of stages	E1	E2	P	Movitec	
				VF/VSF; VCF	
				F1	F2
[mm]					
4	195	145	-	1051	721
5	195	145	-	1129	799
6	195	145	-	1207	877
7	220	167	-	1306	955
8	220	167	-	1384	1033
9	220	167	-	1462	1111

Dimensions
Motor version V1

Number of stages	E1	E2	P	Movitec	
				VF/VSF; VCF	
				F1	F2
[mm]					
10	260	192	300	1664	1279

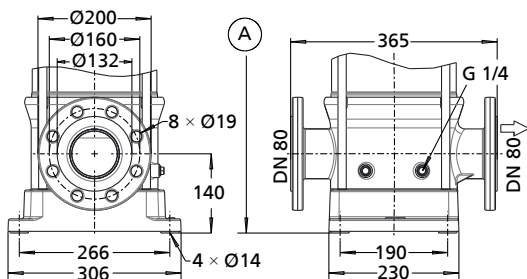

Movitec VF/VSF

Movitec, 40B, n = 2900 rpm

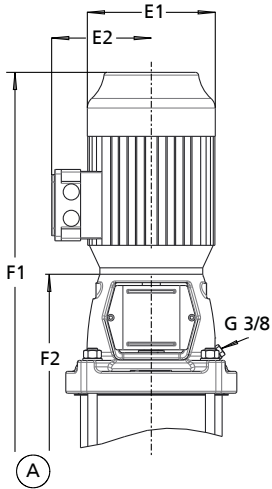

Movitec VF/VSF; VCF
Motor version V18

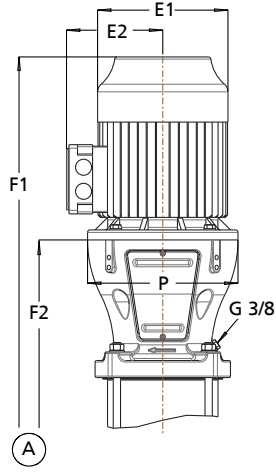

Movitec VF/VSF; VCF
Motor version V1

Dimensions Motor version V18

Number of stages - blind stages	E1	E2	P	Movitec	
				VF/VSF; VCF	
				F1	F2
[mm]					
1-1	195	145	-	817	487
1	223	167	-	827	487

Dimensions Motor version V1

Number of stages - blind stages	E1	E2	P	Movitec	
				VF/VSF; VCF	
				F1	F2
[mm]					
2-2	266	178	300	1002	655
2	266	178	300	1002	655
3-2	315	204	350	1261	763
3	315	204	350	1261	763
4-2	315	204	350	1339	841
4	315	204	350	1339	841
5-2	315	204	350	1499	919
5	315	204	350	1499	919
6-2	315	204	350	1577	997
6	350	223	350	1577	997
7-2	350	223	350	1655	1075
7	400	290	400	1725	1075
8-2	400	290	400	1803	1153
8	400	290	400	1803	1153
9-2	400	290	400	1881	1231
9	400	290	400	1881	1231
10-2	400	290	400	1959	1309
10	400	290	400	1959	1309

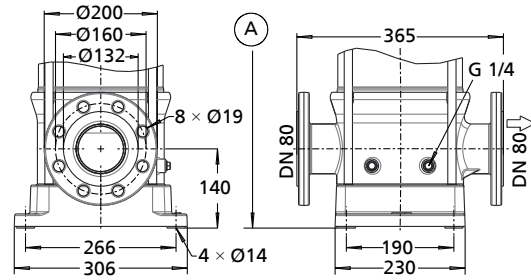

Movitec VF/VSF; PN 16, 25

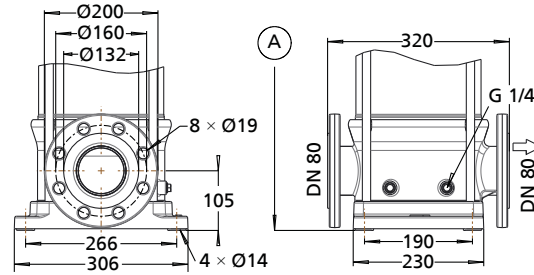

Movitec VF/VSF; PN 16, 25 - interchangeable range

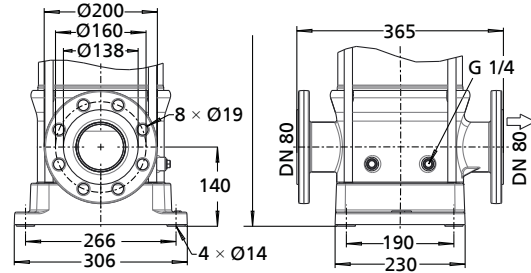

Movitec VF/VSF; PN 40

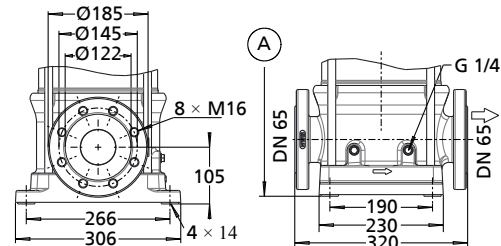

Movitec VCF; DN 65

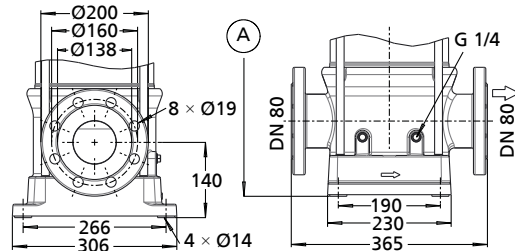

Movitec VCF; DN 80

Movitec, 60B, n = 1450 rpm

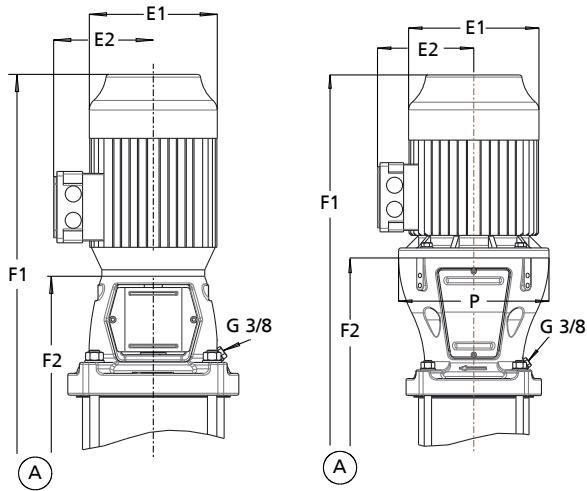

Movitec VF/VSF; VCF
Motor version V18

Movitec VF/VSF; VCF
Motor version V1

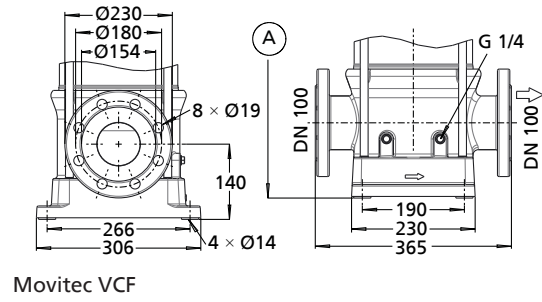

Movitec VCF

Dimensions
Motor version V18

Number of stages	E1	E2	P	Movitec	
				VF/VSF; VCF	
				F1	F2
[mm]					
3	195	145	-	973	643
4	195	145	-	1051	721
5	220	167	-	1150	799
6	220	167	-	1228	877

Dimensions
Motor version V1

Number of stages	E1	E2	P	Movitec	
				VF/VSF; VCF	
				F1	F2
[mm]					
7	260	192	300	1430	1045
8	260	192	300	1508	1123
9	260	192	300	1586	1201
10	260	192	300	1664	1279

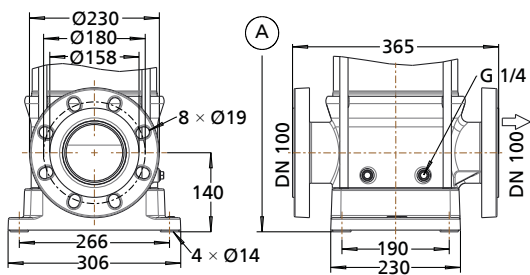

Movitec VF/VSF

Movitec, 60B, n = 2900 rpm

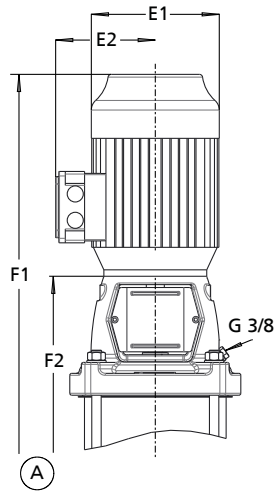

Movitec VF/VSF; VCF
Motor version V18

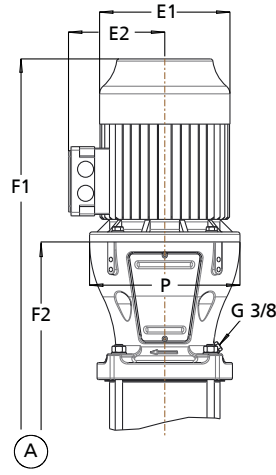

Movitec VF/VSF; VCF
Motor version V1

Dimensions
Motor version V18

Number of stages	E1	E2	P	Movitec	
				VF/VSF; VCF	
				F1	F2
[mm]					
1	223	167	-	827	487

Dimensions
Motor version V1

Number of stages - blind stages	E1	E2	P	Movitec	
				VF/VSF; VCF	
				F1	F2
[mm]					
1	266	178	300	942	577
2-2	266	178	300	1020	655
2	315	204	350	1183	685
3-2	315	204	350	1261	763
3	315	204	350	1341	763
4-2	315	204	350	1421	841
4	350	223	350	1421	841
5-2	350	223	350	1499	919
5	400	290	400	1569	919
6-2	400	290	400	1647	997
6	400	290	400	1647	997
7-2	400	290	400	1725	1075
7	400	290	400	1725	1075
8-2	400	290	400	1803	1153
8	466	335	450	1848	1153
9-2	466	335	450	1926	1231

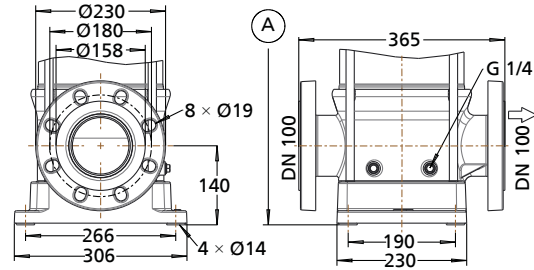

Movitec VF/VSF; PN 16

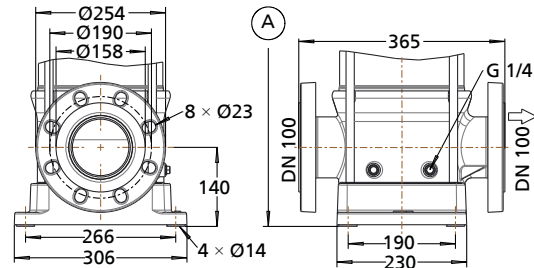

Movitec VF/VSF; PN 25, 40

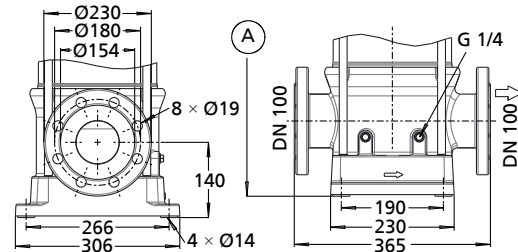

Movitec VCF; PN 16

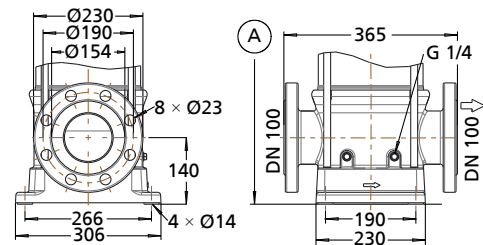

Movitec VCF; PN 25, 40

Movitec, 90B, n = 1450, 2900 rpm

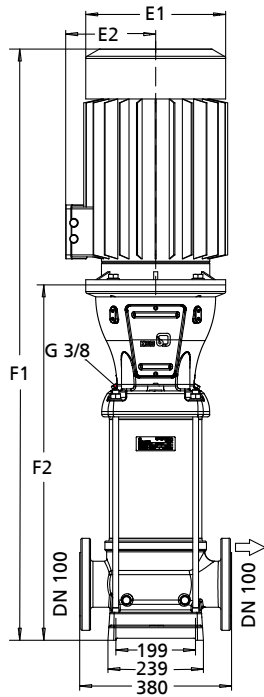

Movitec VF/VSF; VCF

Dimensions 2900 rpm

Number of stages - blind stages	E1	E2	Movitec	
			VF/VSF; VCF	
	F1	F2	[mm]	
1-1	233	162	970	641
1	266	179	1062	641
2-2	315	206	1282	780
2-1	315	206	1282	780
2	315	206	1282	780
3-2	315	206	1435	889
3-1	350	225	1484	889
3	350	225	1484	889
4-2	450	355	1713	998
4-1	350	355	1713	998
4	350	355	1713	998
5-2	350	355	1822	1107
5-1	350	355	1822	1107
5	350	355	1822	1107
6-2	466	373	1953	1216
6-1	466	373	1953	1216
6	466	373	1953	1216

Dimensions 1450 rpm

Number of stages - blind stages	E1	E2	Movitec	
			VF/VSF; VCF	
	F1	F2	[mm]	
5-2	266	179	1460	1077
5-1	266	179	1460	1077
5	266	179	1460	1077
6-2	266	179	1569	1186
6-1	266	179	1569	1186
6	266	179	1569	1186

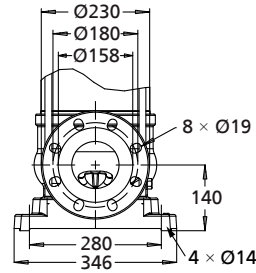

Movitec VF/VSF, PN 16

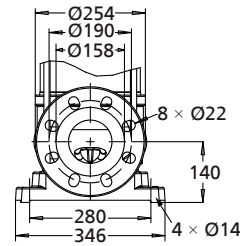

Movitec VF/VSF, PN 25/40

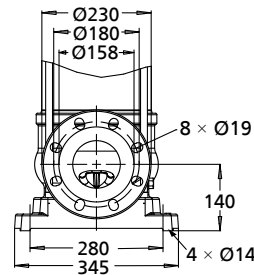

Movitec VCF, PN 16

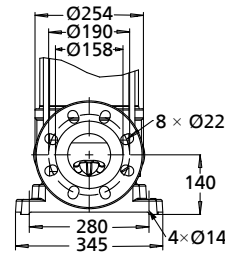

Movitec VCF, PN 25/40

Movitec, LHS 6, n = 2900 rpm

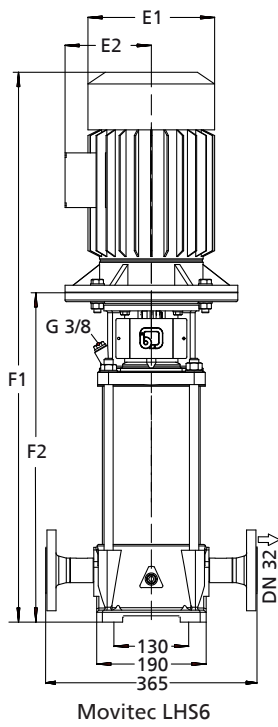

Dimensions

Number of stages	E1	E2	F1	F2
	[mm]			
10	233	162	928	599
12	233	162	1015	658
14	233	162	1250	718
16	315	206	1310	808
18	315	206	1369	867
20	315	206	1429	927

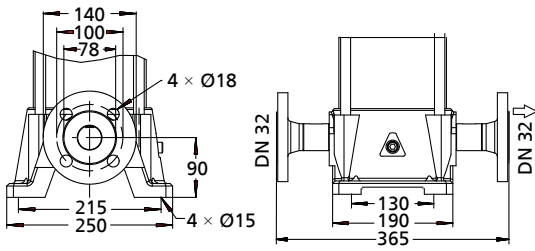

Installation information

Standard:

- Vertical installation

(⇒ Page 34)

Optional:

- Horizontal installation

(for motor ratings up to and including 7.5 kW in systems where the installation conditions do not allow vertical installation)

Movitec 2B, 4B, 6B

a)

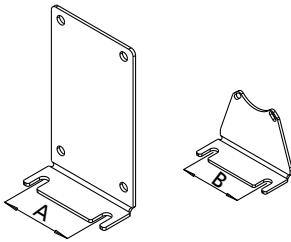

b)

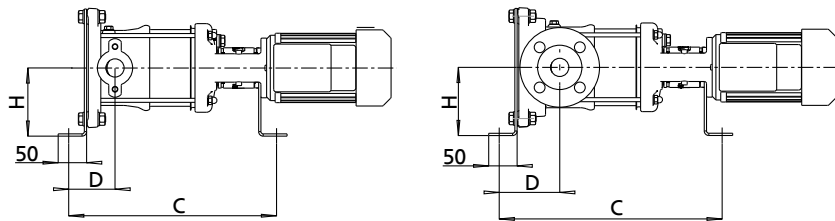

a) Pump bracket b) Pump set

Installation dimensions of the pump bracket as a function of the motor rating

P _N	A	B	C ²⁶⁾	D		H	[kg]	Mat. No.
				-, E, T, V	F			
[kW]	[mm]							
0,37/0,55 kW (2-pole)	100	100	F2+49	82	107	120	2	48895741
0,75/1,10 kW (2-pole)	100	100	F2+49	82	107	120	2.3	48895742
1,50/2,20 kW (2-pole)	100	100	F2+47	82	107	120	2.5	48895743
3,00/4,00 kW (2-pole)	100	100	F2+47	82	107	120	3	48895744
5,50/7,50 kW (2-pole)	100	210	F2-18	82	107	170	3.5	48895745

Movitec 10B, 15B

a)

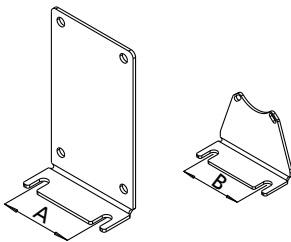

b)

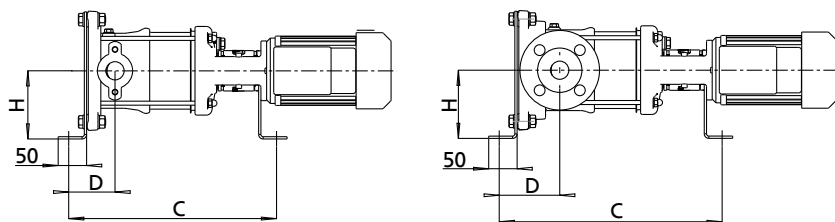

a) Pump bracket b) Pump set

²⁶⁾ F2: see the section on Dimensions

Installation dimensions of the pump bracket as a function of the motor rating

P _N	A	B	C ⁽²⁶⁾	D		H	[kg]	Mat. No.
				- , E, F, T, V 10B -, E 15B	F, T, V 15B			
[kW]	[mm]							
0,75/1,10 kW (2-pole)	130	130	F2+49	111,5	121,5	140	2.786	01338571
0,55/0,75 kW (4-pole)								
1,50/2,20 kW (2-pole)	130	130	F2+47	111,5	121,5	140	2.799	01338572
1,10/1,52 kW (4-pole)								
3,00/4,00 kW (2-pole)	130	130	F2+47	111,5	121,5	140	2.766	01338573
2,20/4,00 kW (4-pole)								
5,50/7,50 kW (2-/4-pole)	130	210	F2-18	111,5	121,5	170	3.116	01338574

Movitec 25B

a)

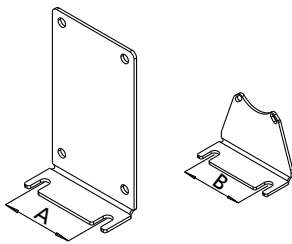

b)

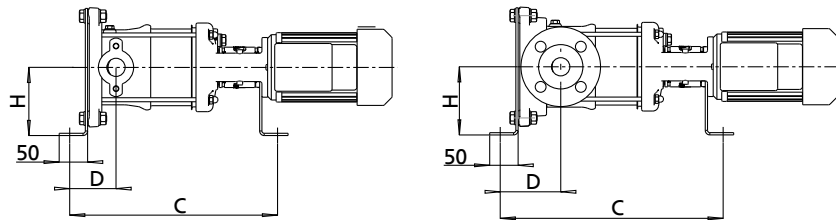

a) Pump bracket b) Pump set

Installation dimensions of the pump bracket as a function of the motor rating

P _N	A	B	C ⁽²⁶⁾	D		H	[kg]	Mat. No.
				[mm]				
1,50/2,50 kW (2-pole)	170	180	F2+47	136,5		170	2.799	1498693
3,00/4,00 kW (2-pole)	170	180	F2+47	136,5		170	2.799	1498694
5,50/7,50 kW (2-pole)	170	210	F2-16	136,5		170	3.116	1498695

Movitec 40B, 60B

a)

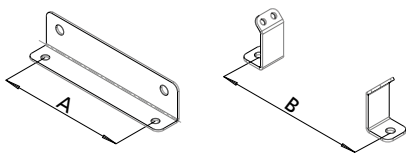

b)

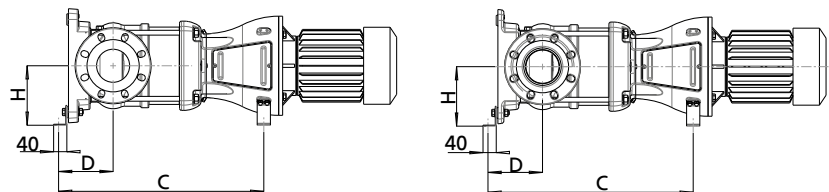

a) Pump bracket b) Pump set

Installation dimensions of the pump bracket as a function of the motor rating

P _N	A	B	C ⁽²⁶⁾	D		H	[kg]	Mat. No.
				[mm]				
3,00/4,00 kW (2-pole)	190	180	F2-16	165		180	2.799	01582128
2,20/4,00 kW (4-pole)								
5,50/7,50 kW (2-/4-pole)	190	250	F2-20	165		180	3.116	01582129

Movitec 90B

a)

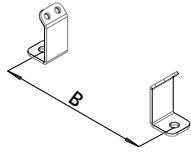
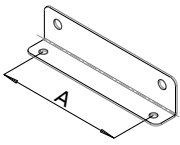

b)

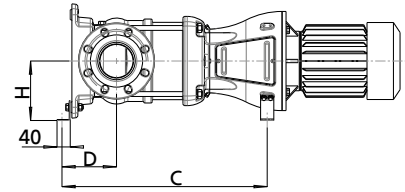
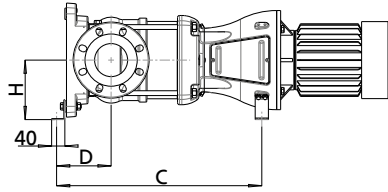

a) Pump bracket b) Pump set

Installation dimensions of the pump bracket as a function of the motor rating

P_N	A	B	C ²⁶⁾	D	H	[kg]	Mat. No.	
[kW]	[mm]							
5,50/7,50 kW (2-/4-pole)	210	250	F2-16	165	180	3.8	48895593	

Scope of supply

Depending on the model, the following items are included in the scope of supply:

- Pump
- Electric motor

Accessories

Possible accessories:

- Frequency inverter, see type series booklet PumpDrive (4074.5)

General assembly drawing with list of components

Movitec 2B, 4B, 6B

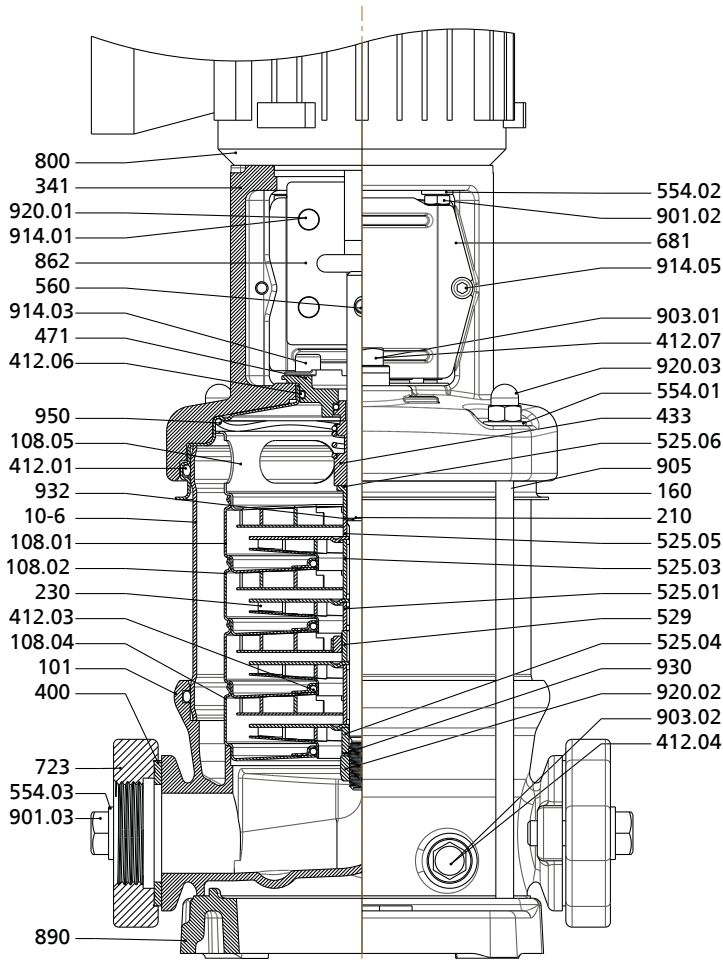

General assembly drawing of Movitec 2B, 4B, 6B

List of components

Part No.	Description	Part No.	Description
10-6	Pump shroud	560	Pin
101	Pump casing	681	Coupling guard
108	Stage casing	723	Flange
160	Cover	800	Motor
210	Shaft	862	Coupling
230	Impeller	890	Baseplate
341	Drive lantern	901	Hexagon head bolt
400	Gasket	903	Vent plug
412	O-ring	905	Tie bolt
433	Mechanical seal	914	Hexagon socket head cap screw
471	Seal cover	920	Nut
525	Spacer sleeve	930	Safety device
529	Bearing sleeve	932	Circlip
554	Washer	950	Spring

Movitec 10B, 15B

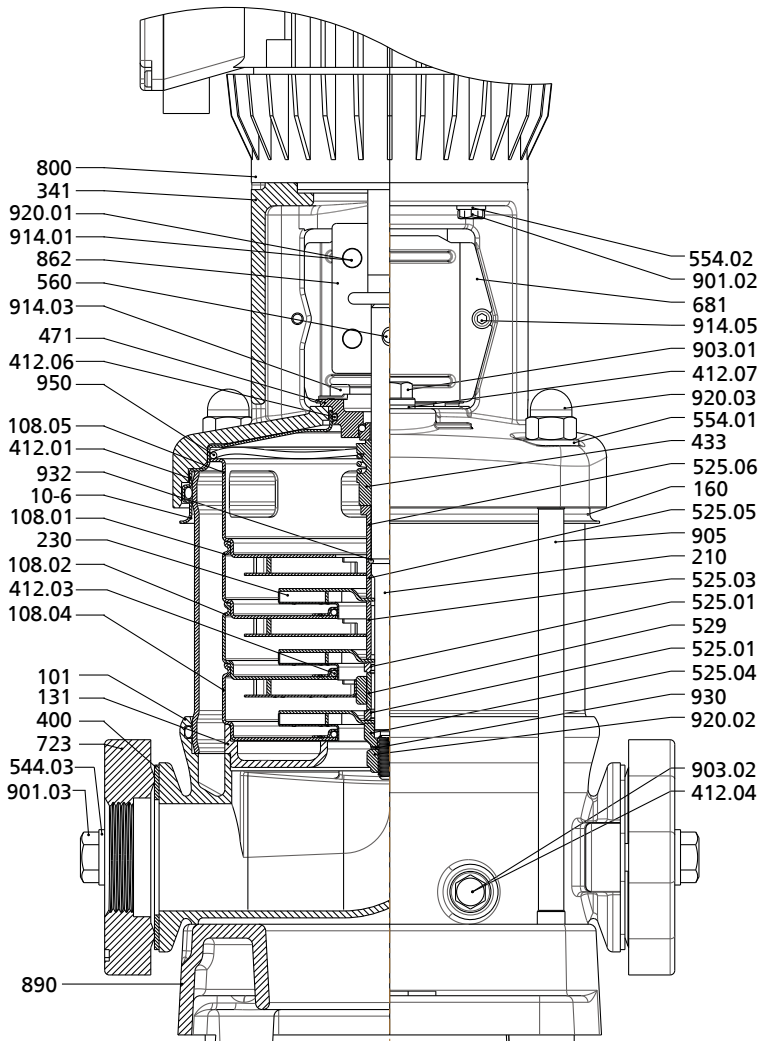

General assembly drawing of Movitec 10B, 15B

List of components

Part No.	Description	Part No.	Description
10-6	Pump shroud	554	Washer
101	Pump casing	560	Pin
108	Stage casing	681	Coupling guard
131	Inlet ring	723	Flange
160	Cover	800	Motor
210	Shaft	862	Coupling
230	Impeller	890	Baseplate
341	Drive lantern	901	Hexagon head bolt
400	Gasket	903	Vent plug
412	O-ring	905	Tie bolt
433	Mechanical seal	914	Hexagon socket head cap screw
471	Seal cover	920	Nut
525	Spacer sleeve	930	Safety device
529	Bearing sleeve	932	Circlip
544	Threaded bush	950	Spring

Movitec 25B, 40B, 60B

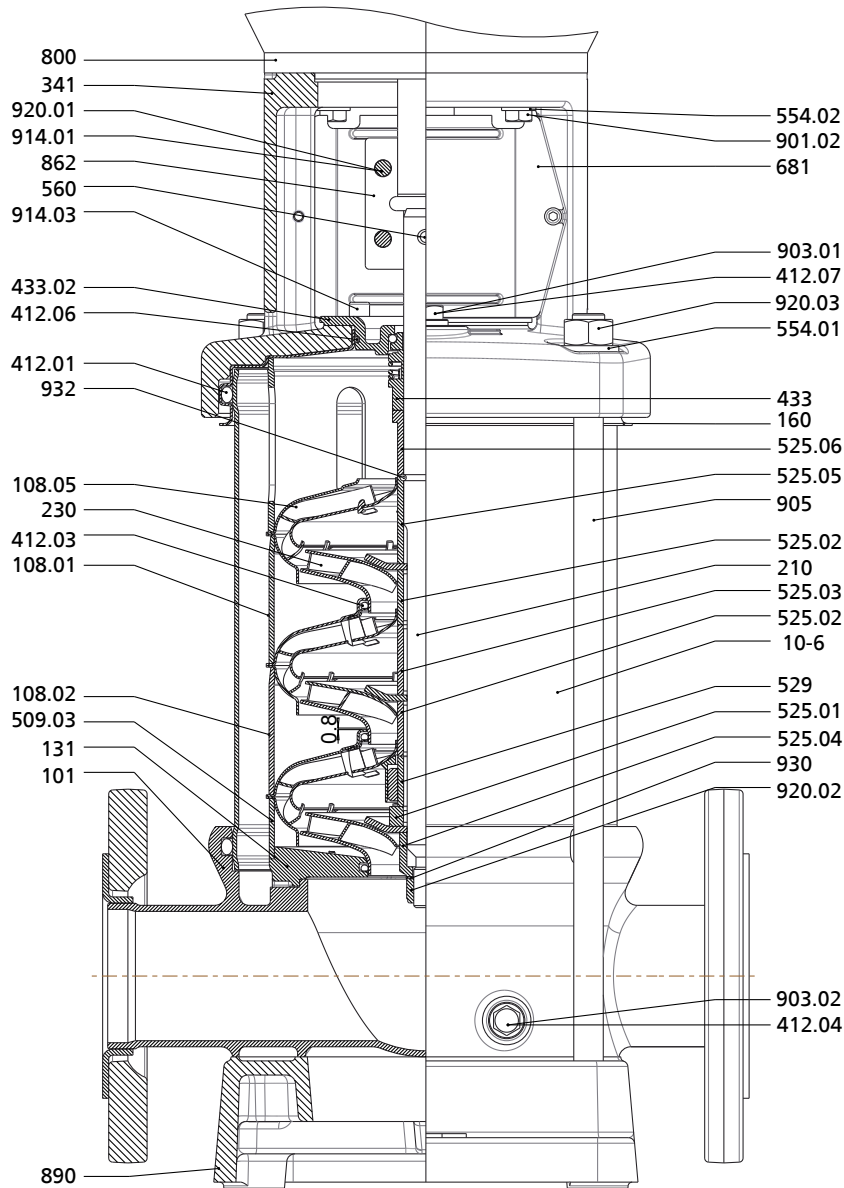

General assembly drawing of Movitec 25B, 40B, 60B

List of components

Part No.	Description	Part No.	Description
10-6	Pump shroud	554	Washer
101	Pump casing	560	Pin
108	Stage casing	681	Coupling guard
131	Inlet ring	800	Motor
160	Cover	862	Coupling
210	Shaft	890	Baseplate
230	Impeller	901	Hexagon head bolt
341	Drive lantern	903	Vent plug
412	O-ring	905	Tie bolt
433	Mechanical seal	914	Hexagon socket head cap screw
509	Intermediate ring	920	Nut
525	Spacer sleeve	930	Safety device
529	Bearing sleeve	932	Circlip
544	Threaded bush		

Movitec 90B

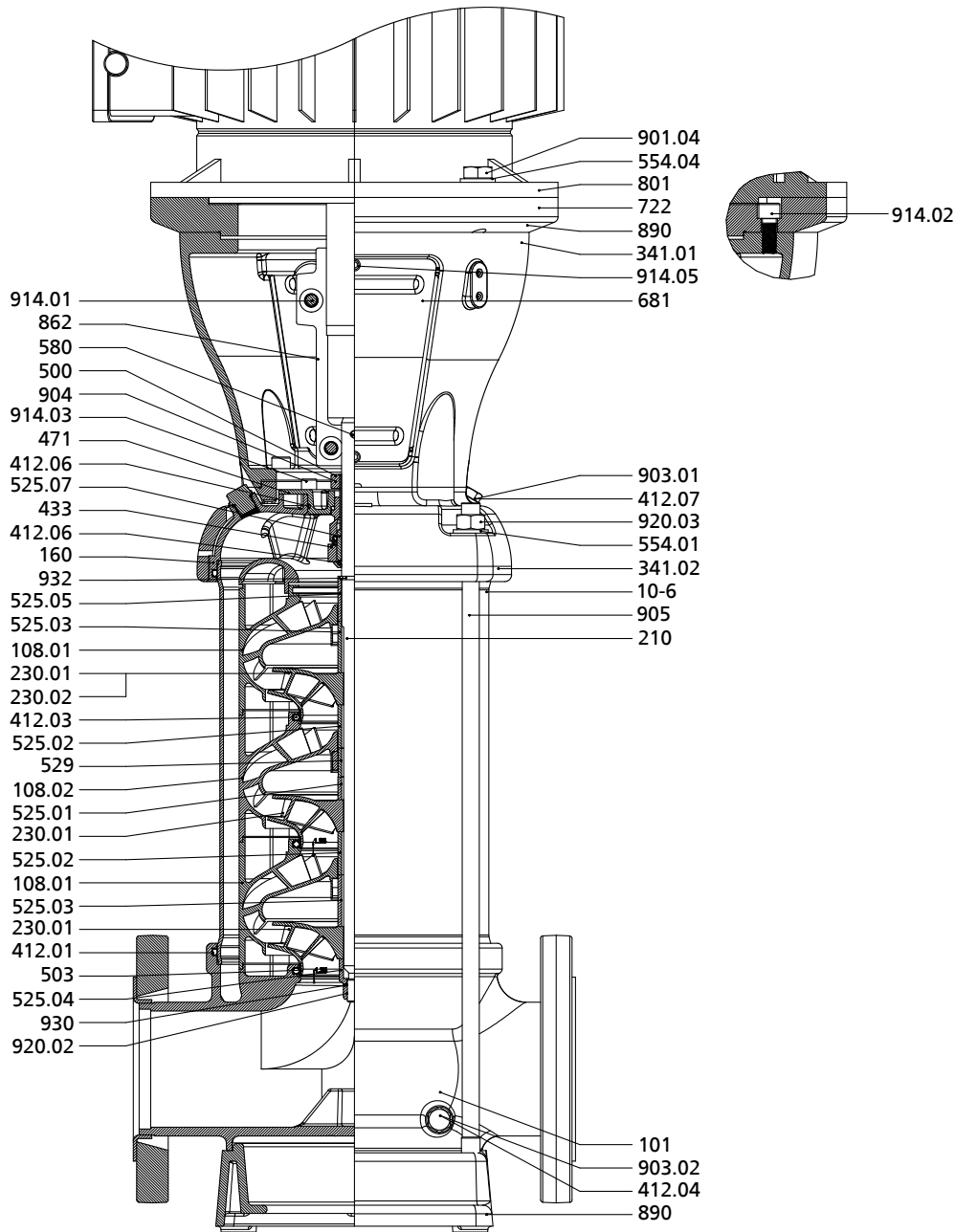

General assembly drawing of Movitec 90B

List of components

Part No.	Description	Part No.	Description
108	Stage casing	580	Cap
160	Cover	681	Coupling guard
230	Impeller	722	Double-flanged taper
341	Drive lantern	801	Flanged motor
412	O-ring	862	Coupling
433	Mechanical seal	890	Baseplate
471	Seal cover	901	Hexagon head bolt
500	Ring	904	Grub screw
503	Impeller wear ring	914	Hexagon socket head cap screw
525	Spacer sleeve	920	Nut
529	Bearing sleeve	930	Safety device
554	Washer	932	Circlip

Movitec LHS 6

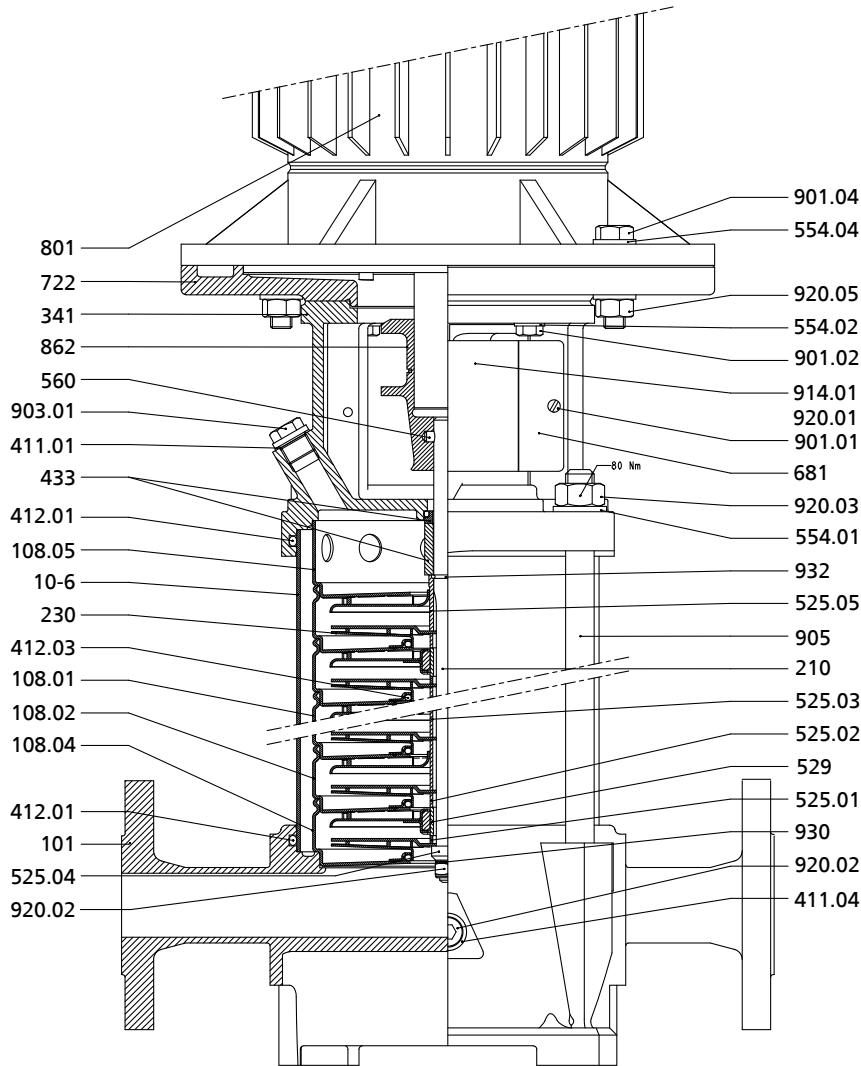

General assembly drawing of Movitec LHS 6

List of components

Part No.	Description	Part No.	Description
10-6	Pump shroud	560	Pin
101	Pump casing	681	Coupling guard
108	Stage casing	722	Double-flanged taper
210	Shaft	801	Flanged motor
230	Impeller	862	Coupling
341	Drive lantern	901	Hexagon head bolt
411	Joint ring	903	Vent plug
412	O-ring	905	Tie bolt
433	Mechanical seal	914	Hexagon socket head cap screw
525	Spacer sleeve	920	Nut
529	Bearing sleeve	930	Safety device
554	Washer	932	Circlip

Detailed designation

Designation example

Position																															
1	2	3	4	5	6	7	8	9	10	11	12	13	14	15	16	17	18	19	20	21	22	23	24	25	26	27	28	29	30	31	32
M	o	v	i	t	e	c	V		F	0	0	6	/	0	6	1	B	3	D	1	3	E	S	1	1	2	B	7	D	A	X
See name plate and data sheet																See data sheet															

Position 1-7: designation

Code	Description
Movitec	Movitec

Position 8-9: design

Code	Description
V	1.4301
VC	1.4301 / EN-GJL-250
VM	1.4301 / Monobloc-Motor
VS	1.4404
LH	1.4404

Position 10: connection type

Code	Description
²⁷⁾	Oval flange
^{E28)}	External thread
F	Round flange
S	Round flange
T	Tri-clamp fitting
V	Victaulic coupling

Position 11-13: size

Code	Description
002	Size 2
004	Size 4
006	Size 6
010	Size 10
015	Size 15
025	Size 25
040	Size 40
060	Size 60
090	Size 90

Position 15-16: number of stages

Code	Description
01	1 stage
02	2 stages
03	3 stages
04	4 stages
05	5 stages
06	6 stages
07	7 stages
08	8 stages
09	9 stages
10	10 stages
11	11 stages
12	12 stages
13	13 stages
14	14 stages
15	15 stages
16	16 stages
17	17 stages
18	18 stages

Code	Description
19	19 stages
20	20 stages
21	21 stages
22	22 stages
24	24 stages
26	26 stages
28	28 stages
30	30 stages

Position 17: blind stages

Code	Description
-	No blind stage
1	One blind stage
2	Two blind stages

Position 18: generation

Code	Description
A	Generation until 2009
B	Generation from 2010

Position 19: standard of connection

Code	Description
0	Victaulic coupling / no standard
1	Round flange / EN 1092
2	Round flange / ASME B16.1
3	Round flange / JIS B2238
4	Oval flange / EN ISO 228-1
5	Oval flange / ASME B16.5
6	Tri-clamp fitting / DIN 32676
7	External thread / EN ISO 228-1
8	Oval flange/ ISO 7-1
9	Round flange / ASME B16.5

Position 20: material variant

Code	Description
D	1.4308 - EN-GJS-400-15 - EN-GJL-250
E	1.4308 - EN-GJS-400-15 - 1.4308
F	1.4308 - 1.4308 - EN-GJL-250
G	1.4308 - 1.4308 - EN-GJS-400-15
H	1.4308 - 1.4308 - 1.4308
K	1.4308 - 1.4408 - EN-GJS-400-15
L	1.4308 - 1.4408 - EN-GJL-250
M	1.4308 - 1.4408 - 1.4308
N	1.4308 - EN-GJS-400-15 - EN-GJL-250
O	1.4408 - EN-GJS-400-15 - 1.4308
P	1.4408 - 1.4308 - EN-GJL-250
Q	1.4408 - 1.4308 - 1.4308
R	1.4408 - 1.4408 - EN-GJL-250
S	1.4408 - 1.4408 - EN-GJS-400-15
T	1.4408 - 1.4408 - 1.4308
U	EN-GJL-250 - EN-GJL-250 - EN-GJL-250

²⁷⁾ Blank

²⁸⁾ Pumps with external thread are supplied with an integrated swing check valve as standard.

Code	Description
V	EN-GJS-400-15 - EN-GJS-400-15 - EN-GJS-400-15
W	EN-GJS-400-15 - 1.4308 - EN-GJS-400-15
X	1.4308 - EN-GJS-400-15 - EN-GJS-400-15
Y	1.4408 - EN-GJS-400-15 - EN-GJS-400-15
Z	1.4408 - 1.4308 - EN-GJS-400-15

Position 21-22: seal code

Code	Description
11	B Q1 E G G
12	B Q1 V G G
13	Q1 B E G G
14	Q1 B V G G
15	U3 U3 X4 G G
16	U3 U3 V G G
18	U3 B E G G
20	Q1 A E G G
21	Q1 A V G G
22	Q1 A X4 G G
23	Q1 B E G G
24	Q1 Q1 V G G
28	Q1 Q1 X4 G G
29	Q1 Q1 E G G

Position 23: mechanical seal design

Code	Description
F	"Fixed" design
E	"Easy access" design
C	Cartridge design

Position 24: drive

Code	Description
0	Without motor
2	With PumpDrive 2
A	ATEX IEC
D	With PumpDrive Basic
E	With PumpDrive 2 Eco
G	With PumpDrive Advanced
N	Standard NEMA
P	With PumpDrive
S	Standard IEC

Position 25-27: motor rating and number of poles

Code	Description
056	NEMA 56C
071	IEC 071
080	IEC 080
090	IEC 090
100	IEC 100
112	IEC 112
132	IEC 132
143	NEMA 143TC
145	NEMA 145TC
160	IEC 160
180	IEC 180
182	NEMA 182TC
184	NEMA 184TC
200	IEC 200
215	NEMA 215TC
225	IEC 225
256	NEMA 256TC
284	NEMA 284TC
286	NEMA 286TC
324	NEMA 324TC
326	NEMA 326TC
364	NEMA 364TC

Position 28: pressure class

Code	Description
A	PN16 / PN25
B	PN25
C	PN25 / PN40
D	PN40

Position 29: mains frequency

Code	Description
5	50 Hz, 2-pole
6	60 Hz, 2-pole
7	50 Hz, 4-pole
8	60 Hz, 4-pole

Position 30: motor specification

Code	Description
C	230/400 V - IE2
D	400/690 V - IE2
F	EXM IEC - TBH
G	EXM NEMA
J	400/690 V - IE2 - PD/PC
K	EXM IEC - Movitec
L	400/690 V - EFF1 - PDX/PCT
M	230 V - single-phase
N	230/400V - IE2 - PD/PC
O	0.37/0.55 kW - without IE classification
U	230/400 V - IE3
V	400/690 V - IE3
W	230/400 V - IE4 (SuPremE)
X	400/690 V - IE4 (SuPremE)

Position 31: PumpMeter

Code	Description
A	With PumpMeter
W	Without PumpMeter

Position 32: standard design

Code	Description
X	One or several non-standard components



LENNTECH

info@lennotech.com Tel. +31-152-610-900
www.lennotech.com Fax. +31-152-616-289